

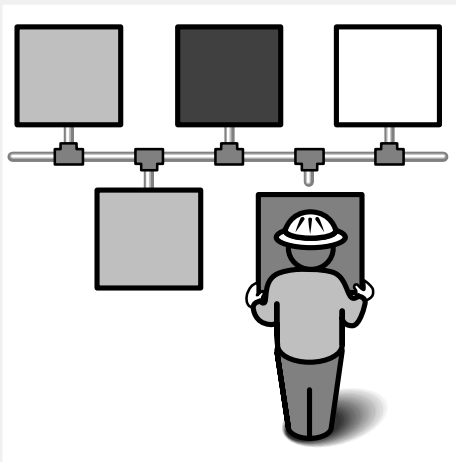

Allen-Bradley

***DF1 Protocol and
Command Set***

Reference Manual



Important User Information

Because of the variety of uses for the products described in this publication, those responsible for the application and use of this control equipment must satisfy themselves that all necessary steps have been taken to assure that each application and use meets all performance and safety requirements, including any applicable laws, regulations, codes and standards.

The illustrations, charts, sample programs and layout examples shown in this guide are intended solely for purposes of example. Since there are many variables and requirements associated with any particular installation, Allen-Bradley does not assume responsibility or liability (to include intellectual property liability) for actual use based upon the examples shown in this publication.

Allen-Bradley publication SGI-1.1, *Safety Guidelines for the Application, Installation, and Maintenance of Solid-State Control* (available from your local Allen-Bradley office), describes some important differences between solid-state equipment and electromechanical devices that should be taken into consideration when applying products such as those described in this publication.

Reproduction of the contents of this copyrighted publication, in whole or in part, without written permission of Allen-Bradley Company, Inc., is prohibited.

Throughout this manual we use notes to make you aware of safety considerations:



ATTENTION: Identifies information about practices or circumstances that can lead to personal injury or death, property damage or economic loss.

Attention statements help you to:

- identify a hazard
- avoid the hazard
- recognize the consequences

Important: Identifies information that is critical for successful application and understanding of the product.

What's Changed in This Document

About This Document

This document contains important information concerning the DF1 Protocol and Command Set Reference Manual.

This information extends and explains information provided in the Data Highway/Data Highway Plus™/DH-485 Communication Protocol and Command Set Reference Manual, publication 1770-6.5.16 — November 1991

Changes to this document are indicated by a revision bar in the margin.

Changes to This Document

The “look and feel” of your Allen-Bradley documentation has changed! We’re constantly trying to improve our documentation to make it more usable for you. If you have questions or comments about this document, complete the enclosed Publication Problem Report. In addition, we’ve also made the following changes to publication 1770-6.5.16:

Change	Description	Reference
organization	We've reorganized the reference manual to make it easier to find information. We include a “map” of this new organization.	Preface, page P-2
commands	We've added and updated the communication commands. We've also organized them alphabetically. Additional commands include: <ul style="list-style-type: none">• <i>apply port configuration</i>• <i>change mode</i>• <i>close file</i>• <i>disable forces</i>• <i>get edit resources</i>• <i>initialize memory</i>• <i>open file</i>• <i>protected typed logical read with three address fields</i>• <i>protected typed logical write with three address fields</i>• <i>read diagnostic counters</i>• <i>read section size</i>• <i>return edit resource</i>	Chapter 7, “Communication Commands”

Table of Contents

What's Changed in This Document	<u>soc-i</u>
About This Document	<u>soc-i</u>
Changes to This Document	<u>soc-i</u>
About This Manual	<u>P-1</u>
Purpose of This Manual	<u>P-1</u>
Who Should Use This Manual	<u>P-1</u>
What This Manual Contains	<u>P-2</u>
Terms and Abbreviations	<u>P-3</u>
Related Publications	<u>P-3</u>
Related Products	<u>P-4</u>
Conventions Used in This Manual	<u>P-5</u>
Network Layers	<u>1-1</u>
Physical Layer	<u>1-2</u>
DF1 Link	<u>1-2</u>
Network Link	<u>1-2</u>
DH Link	<u>1-3</u>
DH+ Link	<u>1-5</u>
DH485 Link	<u>1-6</u>
Software Layers	<u>1-7</u>
Data-link Layer	<u>1-7</u>
Application Layer	<u>1-8</u>
Message Packet Structure	<u>1-9</u>
Command and Reply Message	<u>1-9</u>
Message Priority	<u>1-10</u>
Delivery Order of Commands	<u>1-10</u>
Types of Commands	<u>1-11</u>
Error Codes	<u>1-11</u>
Understanding DF1 Protocol	<u>2-1</u>
DF1 Protocol	<u>2-2</u>
Half-duplex Protocol	<u>2-2</u>
Full-duplex Protocol	<u>2-4</u>
Character Transmission	<u>2-5</u>
Transmission Symbols	<u>2-6</u>

Using Half-duplex Protocols to Send and Receive Messages	3-1
Half-duplex Protocol Message Transmission	3-2
Transmitter and Receiver Message Transfer	3-3
Half-duplex Protocol Environment	3-3
Message Characteristics	3-7
Master Polling Responsibilities	3-7
Duplicate Detection	3-7
Inactive Slave Polling	3-7
Full Sinks	3-8
Simplified Network Layer	3-8
Slave Transceiver Actions	3-9
Half-Duplex Protocol Diagrams	3-11
Normal Message Transfer	3-12
Message Transfer with Invalid BCC/CRC	3-12
Message Transfer with ACK Destroyed	3-13
Poll with No Message Available	3-13
Poll with Message Returned	3-14
Duplicate Message Transmission	3-15
Message Sink Full, Case 1	3-16
Message Sink Full, Case 2	3-17
Using Full-duplex Protocol to Send and Receive Messages	4-1
Full-duplex Protocol Message Transmission	4-2
Full-duplex Protocol Environment	4-3
Message Characteristics	4-4
Transmitter and Receiver Message Transfer	4-4
How the Transmitter Operates	4-5
How the Receiver Operates	4-7
Full-duplex Protocol Diagrams	4-10
Normal Message Transfer	4-10
Message Transfer with NAK	4-11
Message Transfer with Timeout and ENQ	4-12
Message Transfer with Re-Transmission	4-13
Message Transfer with Message Sink Full	4-14
Message Transfer with NAK on Reply	4-15
Message Transfer with Timeout and ENQ for the Reply . . .	4-16
Message Transfer with Message Source Full on the Reply .	4-17

Data-link Layer Message Frames	5-1
Half-duplex Protocol Message Frames	5-2
Polling Frame	5-2
Master Message Frame	5-2
Slave Message Frame	5-2
Full-duplex Protocol Message Frames	5-3
From user application program	5-3
From common application routines	5-3
Data-link layer frame	5-3
BCC and CRC Fields	5-4
BCC Field	5-4
Half-duplex protocol example	5-4
Full-duplex protocol example	5-5
CRC Field	5-6
Full-duplex and half-duplex slave protocol	5-7
Half-duplex master protocol	5-7
Use this frame to validate the CRC	5-7
Application Layer Message Packets	6-1
How Your Application Program Sends and Receives Messages	6-2
Message Packet Format	6-3
Command	6-3
Reply	6-3
DST and SRC	6-4
Command	6-4
Reply	6-4
CMD and FNC	6-5
STS and EXT STS	6-6
TNS	6-7
ADDR	6-8
SIZE	6-8
Communication Commands	7-1
command name	7-1
apply port configuration	7-4
bit write (write bit)	7-4
change mode	7-5
close file	7-5
diagnostic status	7-6
disable forces	7-6
disable outputs	7-6
download all request (download)	7-7
download completed	7-7
download request (download privilege)	7-8

echo	7-8
enable outputs	7-9
enable PLC scanning	7-9
enter download mode	7-9
enter upload mode	7-10
exit download/upload mode	7-10
file read (read file)	7-10
file write (write file)	7-11
get edit resource	7-11
initialize memory	7-12
modify PLC-2 compatibility file	7-12
open file	7-13
physical read	7-13
physical write	7-14
protected bit write	7-15
protected typed file read	7-16
protected typed file write	7-16
protected typed logical read with three address fields	7-17
protected typed logical write with three address fields	7-18
protected write	7-19
read bytes physical (physical read)	7-19
read diagnostic counters	7-19
read link parameters	7-20
read modify-write (write bit)	7-20
read-modify-write N	7-21
read section size	7-22
reset diagnostic counters	7-22
restart request (restart)	7-23
return edit resource	7-24
set data table size	7-24
set ENQs	7-25
set link parameters	7-25
set NAKs	7-25
set CPU mode	7-26
set timeout	7-27
set variables	7-27
shutdown	7-28
typed read (read block)	7-28
typed write (write block)	7-30
unprotected bit write	7-30
unprotected read	7-31
unprotected write	7-32
upload all request (upload)	7-33
upload completed	7-34
upload	7-34

word range read (read block)	7-34
word range write (write block)	7-35
write bytes physical (physical write)	7-35
PLC-5 Type/Data Parameter Examples	7-36
SLC 500 Information	7-38
Reading and Writing SLC 500 Data	7-38
Reading and Writing SLC 500 Data (using PLC-2 terminology)	7-38
Message Packet Status Codes (STS, EXT STS)	8-1
STS Byte	8-2
Local STS Error Codes	8-2
Remote STS Error Codes	8-3
EXT STS Byte	8-3
DH485 EXT STS Codes	8-5
Remote STS and EXT STS Codes	8-5
Remote STS Codes from a PLC-2 or 1774-PLC Processor	8-5
Remote STS and EXT STS Codes from a PLC-3 Processor	8-6
Diagnostic Counters	9-1
1747 Cat. Nos.	9-3
1747-KE DH485 Diagnostic Counters	9-3
1747-L20, -L30, -L40, -L511, -L514, -L524, (SLC 500, 5/01, and 5/02 processors), 1747-PA2x (SLC APS COM1), 1770-KF3, and 1784-KR DH485 Diagnostic Counters	9-3
1747-L541, -L542, and -L543 (SLC 5/04 processors) DH+ Diagnostic Counters	9-4
1747-L541, -L542, and -L543 (SLC 5/03 and 5/04 processors) DH485 Diagnostic Counters	9-5
1747-L541, -L542, and -L543 (SLC 5/03 and SLC 5/04 processors) DF1 Diagnostic Counters	9-6
1761 Cat. Nos.	9-7
1761-L16AWA, -L16BBB, -L16BWB, -L32AWA, -L32BWA, -L32BWB (MicroLogix 1000 processors, Series C or later) DH485 Diagnostic Counters	9-7
1761-L16AWA, -L16BBB, -L16BWB, -L32AWA, -L32BWA, -L32BWB (MicroLogix 1000 processors) DF1 Diagnostic Counters	9-7
1770 Cat. Nos.	9-8
1770-KF2 and 1771-KE/KF DH and Asynchronous Link Diagnostic Counters	9-8
1770-KF2 and 1785-KE DH+ and Asynchronous Link Diagnostic Counters	9-11
1770-KFC DF1 Diagnostic Counters	9-13
1771 Cat. Nos.	9-14
1771-KA, 1771-KA2, and 1774-KA DH Diagnostic Counters	9-14
1771-KC DH Diagnostic Counters	9-16
1771-KG,-KGM Diagnostic Counters	9-19

1775 Cat. Nos.	9-21
1775-KA,-S5,-SR5 DH Diagnostic Counters	9-21
1775-S5,-SR5 DH+ Diagnostic Counters	9-23
1779 Cat. Nos.	9-24
1779-KP5 DH+ Diagnostic Counters	9-24
1784 Cat. Nos.	9-25
1784-KT and 1784-KT2 DH+ Diagnostic Counters	9-25
1785 Cat. Nos.	9-26
1785-KA DH Diagnostic Counters	9-26
1785-KA DH+ Diagnostic Counters	9-27
1785-KA3 DH+ Diagnostic Counters	9-28
1785-KA5 DH+ Diagnostic Counters	9-29
1785-KA5 DH485 Diagnostic Counters	9-30
1785-L11B, -L20B, -L30B, -L40B, -L60B, and -L80B DH+ Channel Diagnostic Counters	9-30
1785-L20E, -L40E, -L40L, -L60L, -L80E DH+ Diagnostic Counters	9-32
5250 Cat. Nos.	9-33
5250-LP1, -LP2, -LP3, -LP4 DH+ Diagnostic Counters	9-33
Diagnostic Status Information	10-1
1747 Cat. Nos.	10-2
1747-KE Status Bytes	10-2
1747-L20, -L30, -L40, -L511, -L514, -L524 (SLC 500, SLC 5/01 and SLC 5/02 processors) Status Bytes	10-3
1747-L532, -L541, -L542, -L543 (SLC 5/03 and SLC 5/04 processors) Status Bytes	10-4
1761, 1770, and 1771 Cat. Nos.	10-5
1761-L16AWA, -L16BBB, -L16BWB, -L32AWA, -L32BWA, -L32BWB (MicroLogix 1000 processors) Status Bytes	10-6
1770-KF3 Status Bytes	10-7
1771-KA2, -KA, -KC/KD, -KE, -KF, -KG, -KGM, 1770-KF2 Status Bytes	10-7
1773, 1775, and 1779 Cat. Nos.	10-11
1773-KA Status Bytes	10-11
1775-KA, -S5 and -SR5 Status Bytes	10-13
1779-KP5 Status Bytes	10-14
1784 Cat. Nos.	10-15
1784-KR Status Bytes	10-15
1784-KT, -KT2 Status Bytes	10-15
1785 Cat. Nos.	10-16
1785-KA Status Bytes	10-16
1785-KA5 Status Bytes	10-17
1785-KA3 Status Bytes	10-17
1785-KE Status Bytes	10-19

1785-LT (PLC-5/15) and 6008-LTV (PLC-5 VME) Status Bytes	10-20
1785-LT3 (PLC-5/12) and 1785-LT2 (PLC-5/25) Status Bytes	10-21
1785-L11B, -L20B, -L20E, -L30B, -L40B, -L40E, -L40L, -L60B, -L60L Status Bytes	10-22
5130 Cat. Nos.	10-23
5130-RM1, -RM2 (PLC-5/250) Status Bytes	10-23
Data Encoding	11-1
Numbering Systems	11-2
Decimal	11-2
Decimal Representation, Number 239	11-2
Binary	11-3
Binary Representation, Number 239	11-3
Binary Coded Decimal	11-3
BCD Representation of Decimal 239	11-3
Hexadecimal	11-4
Hexadecimal Representation of Decimal 423	11-4
Octal	11-5
Octal Representation of Decimal 239	11-5
Binary Floating-point	11-5
Order of Transmission	11-6
A 16-Bit Word in PLC Memory	11-7
A 16-Bit Computer Word with Left-to-Right Byte and Bit Order	11-7
A 16-Bit Computer Word with Right-to-Left Byte and Bit Order	11-7
A 16-Bit Computer Word with Left-to-Right Byte Order and Right-to-Left Bit Order	11-7
Uploading and Downloading with A-B Processors ...	12-1
Uploading from the Processor	12-2
Uploading from a PLC-2 Processor	12-2
Uploading from a PLC-3 Processor	12-2
Uploading from a PLC-5 Processor	12-3
Procedure 1 — PLC-5/15/B processors, revision E and earlier	12-4
Procedure 2	12-5
Uploading from an SLC 500 Processor	12-6
Downloading to the Processor	12-6
Downloading to a PLC-2 Processor	12-7
Downloading to a PLC-3 Processor	12-8
Downloading to a PLC-5 Processor	12-8
Procedure 1 (PLC-5/15/B rev E and earlier)	12-9
Procedure 2	12-10

Downloading to an SLC 500 Processor	12-10
Procedure 1 — SLC 500, SLC 5/01 and SLC 5/02 Processors	12-11
Procedure 2 — SLC 5/03 and SLC 5/04 Processors ...	12-12
PLC Addressing	13-1
PLC-2/1774-PLC Addressing	13-2
PLC-2/1774-PLC Logical Addressing	13-2
PLC-2 Physical Addressing	13-3
1774-PLC Physical Addressing	13-3
PLC-3 Addressing	13-4
PLC-3 Logical Addressing	13-5
PLC-3 Physical Addressing	13-7
PLC-3 Symbolic Addressing	13-8
PLC-5 Addressing	13-9
PLC-5 Logical Addressing	13-10
PLC-5 Logical Binary Addressing	13-11
PLC-5/250 Logical Binary Addressing	13-13
Logical ASCII Addressing	13-15
PLC-5 Physical Addressing	13-16
PLC-5 Floating Point	13-17
Line Monitor Examples	14-1
Half-duplex Line Monitor Example	14-2
Message from master to slave and slave acknowledgement:	14-2
Message sent from slave to master in response to poll and slave acknowledgement:	14-2
Poll with a DLE EOT in response:	14-2
Full-duplex PLC-2 Line Monitor Example	14-3
Full-duplex PLC-3 Line Monitor Example	14-6
ASCII Codes	15-1

About This Manual

Read this preface to familiarize yourself with this manual.

This preface includes information on:

- the purpose of this manual
- who should use this manual
- what this manual contains
- terms and abbreviations used in this manual
- related publications
- related products
- conventions used in this manual

Purpose of This Manual

Use this manual to:

- program a DF1 driver for a computer to interface to Allen-Bradley DF1 products and to proprietary networks via protocol bridges
- write applications for 1784-KT, -KT2, -KTX, -KTXD, -PCMK communication interfaces using standard Rockwell Software Inc. (RSI) driver products
- troubleshoot your network

Who Should Use This Manual



Read this manual before you attempt to write a DF1 driver, or before attempting to troubleshoot your network. We assume that you are already familiar with:

- your serial device
- Allen-Bradley PLC processors

Before you begin writing your driver, make sure you have:

- a pocket calculator that adds, subtracts, multiplies, and divides in decimal, hexadecimal, octal, and binary
- a serial protocol analyzer for displaying actual hex bytes sent to and from a DH, DH+, or DH485 module

▶ Writing drivers

As an alternative to writing your own driver, RSI provides RSLINX C SDK (cat. no. 9355-WABC) and INTERCHANGE (cat. nos. 9351-AIX, -DKTS, -HPUS, -OSF, -VS, -WES, -WKTS) software. These products provide an application programmer's interface (API) and a complete set of drivers to communicate with Allen-Bradley processors via Ethernet, DH, DH+, DH485, and DF1 serial links on various hardware and operating system platforms.

What This Manual Contains

This manual is divided into five units:

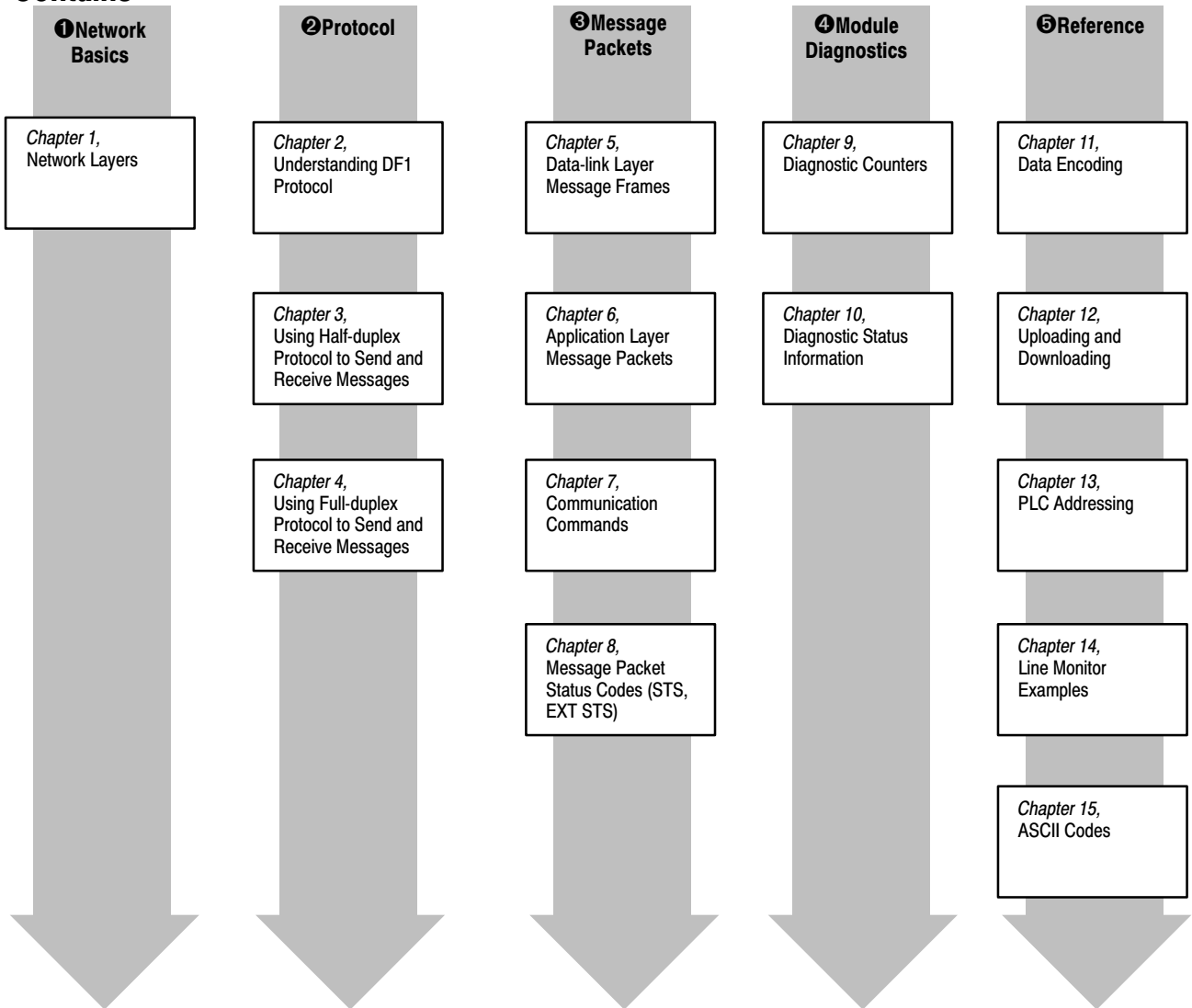

1	2	3	4	5
<p>gain an understanding of the network</p>	<ul style="list-style-type: none"> • understand what DF1 protocol is • understand the difference between half-duplex and full-duplex protocols 	<ul style="list-style-type: none"> • properly configure the data-link layer of your software driver • understand each part of a message packet • learn message packet formats for all commands • asynchronous link status codes that may be sent in the STS fields of your message packet 	<ul style="list-style-type: none"> • diagnostic counters contained in each interface module • information returned from each interface when your computer sends a diagnostic status command 	<ul style="list-style-type: none"> • data encoding and conversion information • upload and download procedures for the PLC-2, PLC-3 and PLC-5 processors • information on addressing PLC-2, PLC-3, PLC-5, and PLC-5/250 processors • line monitor examples that show actual commands being sent and provide an explanation of each example • hex and binary values for ASCII characters

Terms and Abbreviations

Term	Definition
local node	The node sending the command
node	The point at which devices, such as programmable controllers, interface to the network. Each device on a network must have a unique node address. In some Allen-Bradley documentation, you may find the term station used in place of the term node .
physical link	Cable and associated hardware, such as transmitter and receiver circuits.
PLC controller	An Allen-Bradley programmable controller. See programmable controller.
protocol	Set of programming rules for interpreting the signals transmitted over the physical link by nodes.
programmable controller	a solid-state control system that has a user-programmable memory for storage of instructions to implement specific functions such as I/O control, logic, timing, counting, report generation, communication, arithmetic, and data file manipulation. A controller consists of central processor, input/output interface, and memory. A controller is designed as an industrial control system.
remote node	The node sending the reply to the local node
Abbreviation	Definition
ACK	acknowledgement. In communication, ACK is a control code sent by the receiving node to indicate that the data has been received without error and the next part of the transmission may be sent.
DH+	Data Highway Plus. Allen-Bradley proprietary network protocol.
NAK	negative acknowledgement.

Related Publications

Publication Name	Publication Number
DH/DH+/DH II/DH485 Cable Installation Manual	1770-6.2.2
DH Overview Product Data	1770-2.39
DH+ Overview Product Data	1785-2.6
SCADA System Selection Guide	AG-2.1
SCADA System Application Guide	AG-6.5.8

Related Products

Allen-Bradley offers a wide range of interfaces for the DH, DH+, and DH485 networks, including:

Catalog Number	Product	Related Documentation
1747-KE	DH485/RS-232 Interface Module	1747-2.3.7, product data 1747-6.12, user manual
1770-KF2	DH or DH+ Asynchronous (RS-232 or RS-422-A) Interface Module	1770-6.5.13, user manual 1770-6.5.13-RN1 release notes
1770-KF3	DH485 Asynchronous (RS-232) Interface Module	1770-6.5.18, user manual 1770-6.5.18-RN1, release notes 1770-6.5.18-RN2, release notes
1771-KA2	DH PLC-2 Family Communication Adapter Module	1771-5.2, switch settings 1771-6.5.1, user manual
1771-KG	PLC-2 Family RS-232 Interface Module	1771-2.32, product data 1771-6.5.8, user manual 1771-6.5.8-DU1, document update
1771-KGM	SCADA Communication Master Module for PLC-2 Family	1771-2.85, product data 1771-6.5.39, user manual
1771-KE,-KF	DH RS-232 Interface Module	1771-6.5.16, user manual 1771-6.5.16-DU1, document update
1775-KA	DH PLC-3 Communication Adapter Module	1775-6.5.1, user manual
1775-S5,-SR5	PLC-3 I/O Scanner Module	1775-6.5.5, user manual
1784-KR	DH485 Personal Computer Interface Module	1784-2.23, installation data 1784-2.23-RN1, release notes
1784-KT	DH+ PC Interface Module	1784-2.31, installation data
1784-KT2/B	DH+ PS/2 Interface Module	1784-2.21, installation data
1784-KT2/C		1784-6.5.16, user manual
1784-KTX	DH+ PC Interface Module	1784-6.5.22, user manual
1784-KTXD	DH+ PC Interface Module	
1784-PCMK	DH+/DH485 PCMCIA communication interface	1784-6.5.19, user manual
1785-KA	DH/DH+ Communication Interface Module	1785-2.6, product data 1785-6.5.1, user manual
1785-KA3	DH+ PLC-2 Family Communication Adapter Module	1785-2.6, product data 1785-6.5.3, user manual 1785-6.5.3-DU1, document update
1785-KA5	DH+/DH485 Communication Interface Module	1785-6.5.5, user manual
1785-KE	DH+ RS-232 Interface Module	1785-6.5.2, user manual
5130-RM1,-RM2	PLC-5/250 Resource Manager Module	5000-6.2.1, design manual 5000-6.2.10, installation manual
9351-AIX, -DKTS, -HPUS, -OSF, -VS, -WES, -WKTS	INTERCHANGE™ Software	5000-6.4.21, reference manual
9355-WABC	RSLINX™ C SDK Software	





Communication, diagnostic, and driver software

DH 6001-NET Network Communications Software (Series 6001) provides a DH driver for many DEC® computers. For more information, refer to the DH/DH+/DH II™ Network Communication Software Overview (publication 6006-2.3).

Conventions Used in This Manual

We use these conventions in this manual:

This convention:	Is used to:
	call attention to helpful information
	refer you to other Allen-Bradley documents that might be useful

■ Network Basics ■

Network Layers — Chapter 1

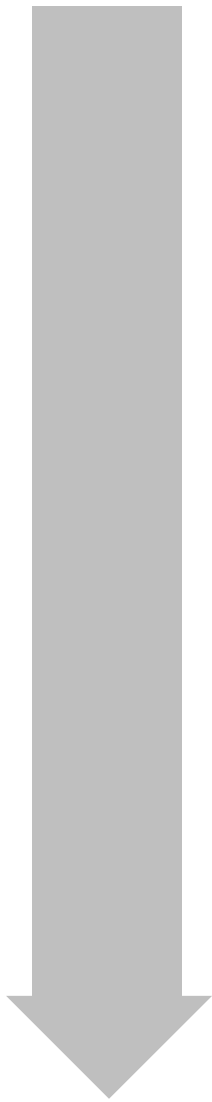

Network Layers

Your network is made up of several layers, including:

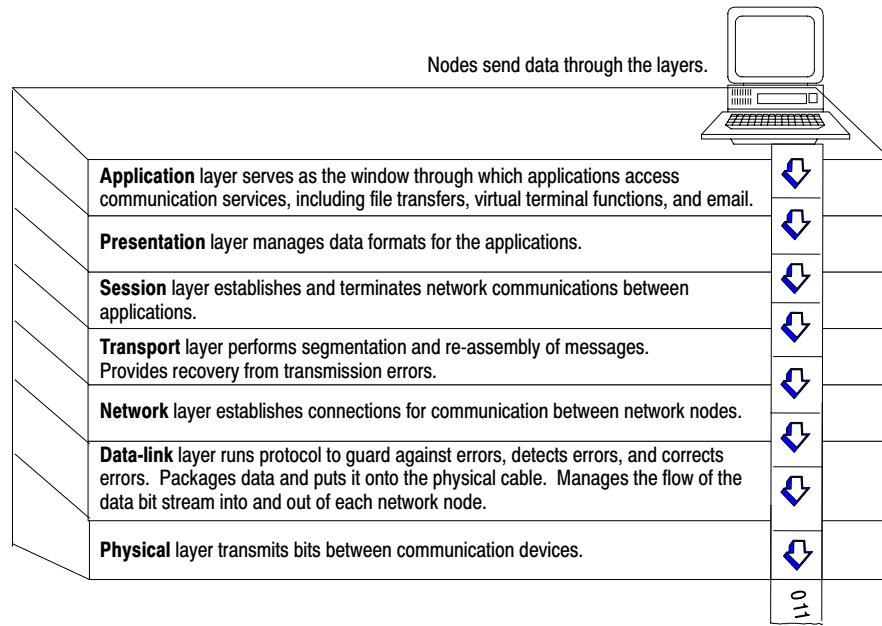

In this chapter, we discuss the physical, data-link, and application layers. (We refer to the data-link and application layers as the **software layers**.) This chapter contains these sections:

Section	Page
Physical Layer	1-2
Software Layers	1-7
Message Packet Structure	1-9

Physical Layer

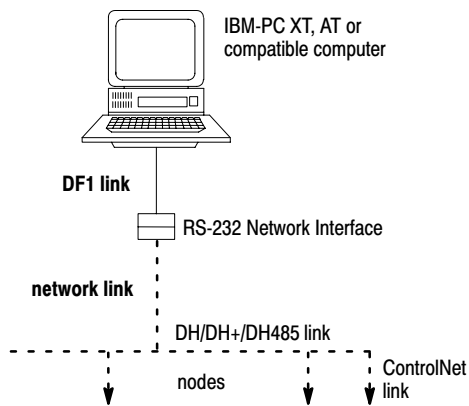

The **physical layer** is a set of cables and interface modules that provides a channel for communication between the nodes. A **node** is a connection point onto a network, typically containing a unique address.

When you connect a computer serially to your DH, DH+, DH-485, or ControlNet link, the interface module acts as an interface between the:

- **DF1 link** (RS-232 or RS-422-A)
- **network link** (DH, DH+, DH485, ControlNet link)

DF1 Link

A DF1 link provides:

- master-slave communication through a half-duplex protocol
- peer-to-peer communication through a full-duplex protocol

This manual provides information necessary to write your own driver for an intelligent device on a DF1 link. See “Software Layers,” on page 1-7, for the layers your software driver must implement so that your intelligent device can talk to other DH, DH+, DH485, or ControlNet nodes.

Network Link

These network links are available for peer-to-peer communication:

This link	Connects	And allows	See page
DH	<ul style="list-style-type: none"> • PLC-2®, PLC-3® processors • color graphic systems • personal computers • host computers • programmable RS232/RS-422 devices 	up to 64 nodes ^①	1-3
DH+	<ul style="list-style-type: none"> • same devices as DH • PLC-5 processors • SLC 5/04 processor 	up to 64 nodes	1-5
DH485	<ul style="list-style-type: none"> • SLC 500 processors • color graphic systems • personal computers 	up to 32 nodes	1-6
ControlNet	<ul style="list-style-type: none"> • PLC-5 processors • I/O devices • personal computers • operator interface devices 	up to 99 nodes	-----

^① Using bridges (e.g., 1785-KA modules), you can extend the length of your DH network to contain up to 255 nodes.

DH Link

A DH link is a local area network (LAN) designed for factory-floor applications. This link accepts 64 devices and can transmit 57.6 K bits of data per second.

A DH link consists of a trunk cable up to 10,000 feet (3,048 meters) long and drop cables as long as 100 feet (30.48 meters) each. Each node is at the end of a drop cable and connects to the DH link through a station connector (cat. no. 1770-SC). This is the *only* configuration tested and supported by Allen-Bradley.

This processor	Connects to a DH link through the
PLC-2 family	DH PLC-2 family communication adapter module (cat. nos. 1771-KA2, -KG)
PLC-3	DH PLC-3 family communication adapter module (cat. nos. 1775-KA, -S5, -SR5)
PLC-5/250	Resource manager module (cat. nos. 5130--KA, -RM1, -RM2)
PLC-5, SLC 5/04 ^①	DH+/DH communication module (cat. no. 1785-KA)

^① Although a PLC-5 processor does not directly connect to a DH link, it can communicate with devices on a DH link via the 1785-KA module.

A DH link implements peer-to-peer communication through a scheme called the **floating master**. With this arrangement, each node has equal access to become the master. The nodes bid for temporary mastership based on their need to send information.

Unlike a master/slave relationship, a floating master relationship does not require the current master to poll each node to grant permission to transmit. Therefore, it provides a more efficient network because there is less overhead—i.e., time—per transaction.

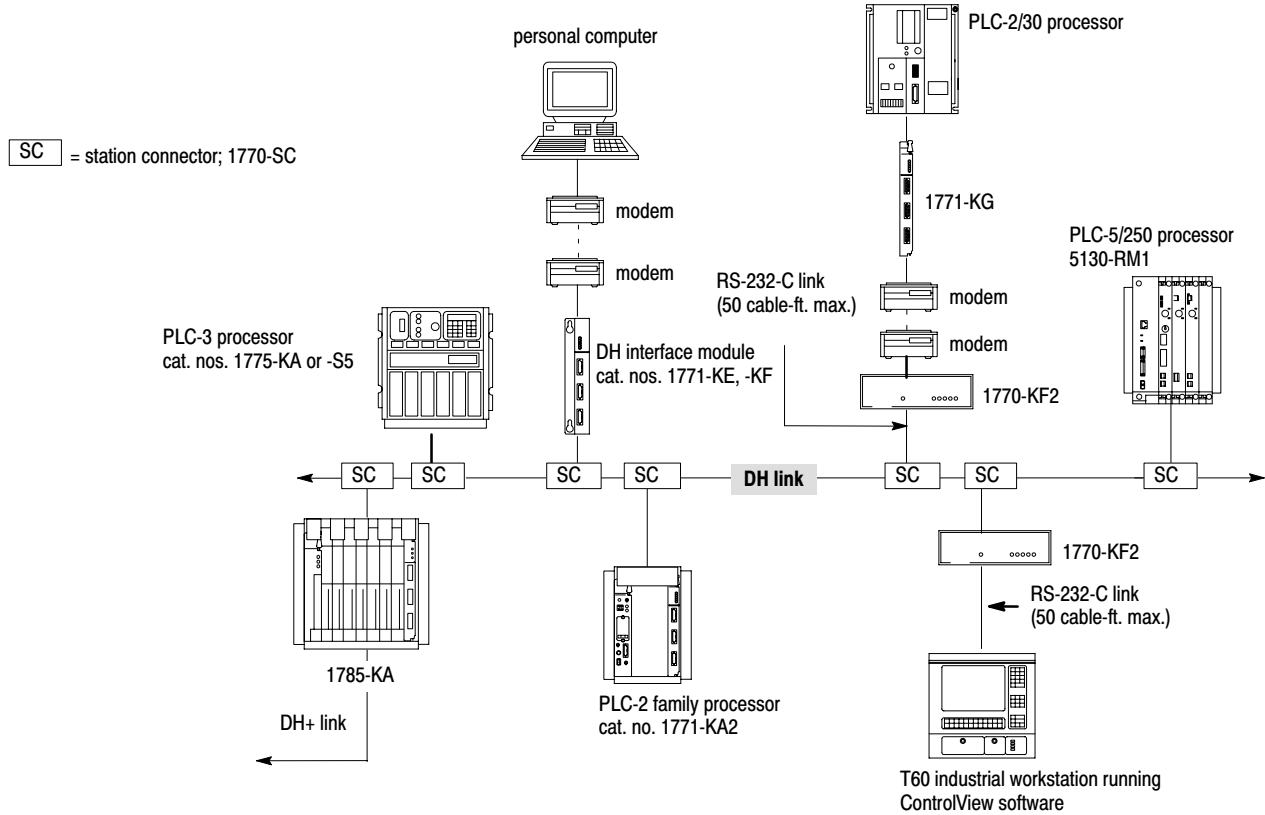

DH+ Link

A DH+ link is similar to a DH link, but is optimally used for smaller networks consisting of limited nodes (about 15 maximum). A DH+ link accepts 64 devices and can transmit data at 57.6, 115.2, or 230.4K bits. (PLC-5/250, SLC, and PLC processors support 57.6 and 115.2K bits; SLC 5/04 processors support 230.4K bits; PLC-5 processors are expected to support 230.4K bits early in 1997.)

This processor	Connects to a DH+ link
PLC-2	through the PLC-2 Family Interface module (cat. no. 1785-KA3)
PLC-3	through the I/O Scanner Communication Adapter module (cat. nos. 1775-S5,-SR5)
PLC-5	directly
PLC-5/250	through the Resource Manager module (cat. nos. 5130-KA, -RM1, -RM2)
SLC 5/04 ^①	directly

^① You can configure the data rate for SLC 5/04 processors.

A DH+ link implements **peer-to-peer** communication with a token-passing scheme to rotate link mastership among the nodes connected to that link.

SC = station connector; 1770-SC

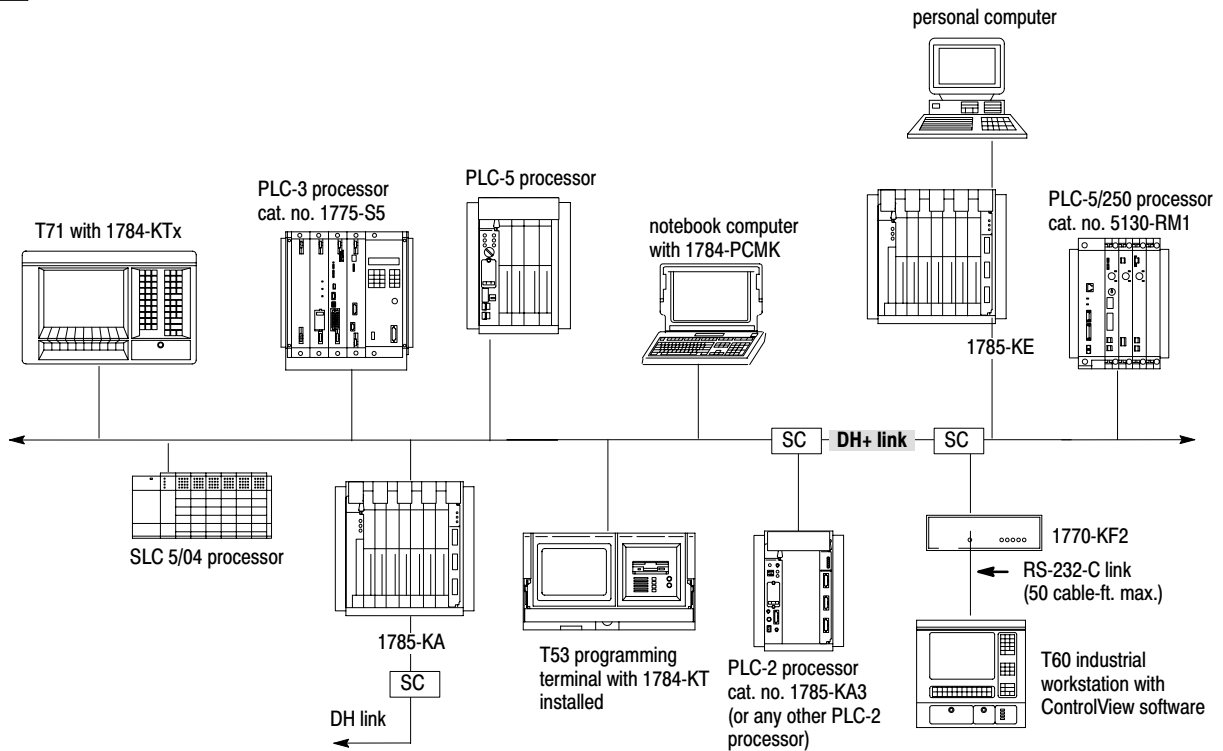

DH485 Link

A DH485 link is a low cost, peer-to-peer programming and data-acquisition link for a variety of Allen-Bradley products. DH485 topology is similar to DH and DH+ topology. You can connect as many as 32 nodes to a DH485 link.

The DH485 link is based on the **Electrical Industries Association (EIA) Standard RS-485 Electrical Signalling Specification**. A variety of Allen-Bradley products (including SLC 500 controllers, 1784-KTX, 1747-KE, 1770-KF3, and operator interface devices) act as token-passing masters on the DH485 link. This link also supports a respond-only mode for low-level devices on the link, such as Allen-Bradley bar code decoders.

A DH485 link implements peer-to-peer communication with a token-passing scheme to rotate link mastership among the nodes connected to that link.

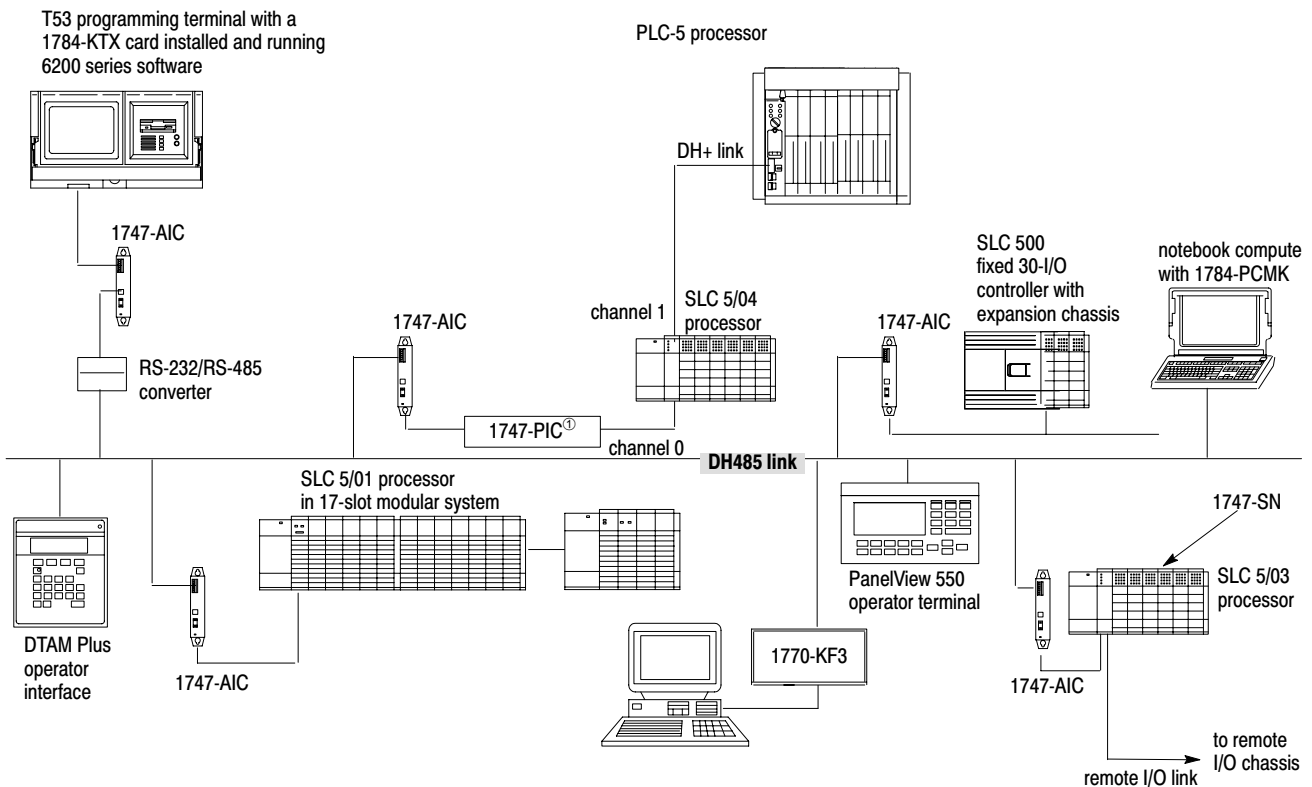

^①To connect an SLC 5/04 to a 1747-PIC, use a 9-pin (male) to 25-pin (female) adapter.

Software Layers

Your DF1 links and network links (DH, DH+, and DH485) each use two layers of software to enable communication:

- the data-link layer
- the application layer

This figure shows how these layers fit together.

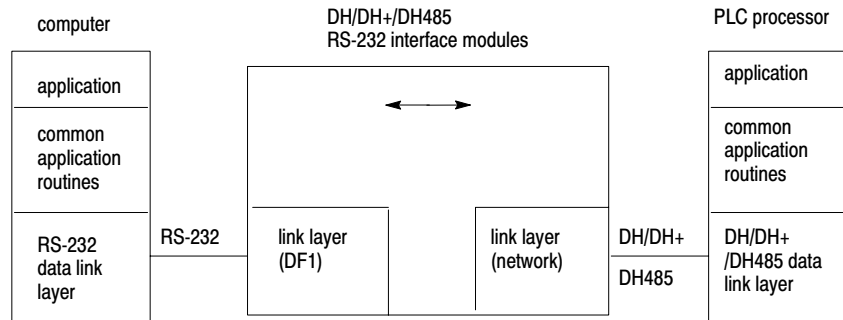

Data-link Layer

This layer controls the flow of communication over the physical link and:

- determines the encoding of data on the physical medium
- controls who transmits data and who listens using an arbitration protocol
- conveys data packets intact from the source node to the destination node over the physical link

If your link is	Then
a DH, DH+ or DH485 link	you do not need to program this layer. Your application programs on the network are not involved with inter-node protocol, handshaking, or control of the link.
a DF1 link between Allen-Bradley interface modules	the interface modules automatically take care of this layer. Your application program does not have to be involved with handshaking control.
a DF1 link between an Allen-Bradley interface module and a computer	you must program this layer at your computer.



Programming the data-link layer

You can program the data link layer using DF1 protocol. For more information, see Chapter 3, “Using Half-duplex Protocol to Send and Receive Messages,” or Chapter 4, “Using Full-duplex Protocol to Send and Receive Messages.”

Application Layer

This layer controls and executes the actual commands specified in the communication between nodes. This layer is the same for both DF1 and network links. The application layer:

- interfaces to user processes and databases
- interprets commands
- formats user data into packets

The application layer depends upon the type of node the application is running on since it must interface to the user process and interpret the user database.



Processes in the application layer

The application layer is typically organized into two types of processes:

- senders — A sender, after receiving a signal from the user process, sends a message and awaits a reply. It then sends the results to the user process.
- responders — A responder waits for an incoming message from the link. When the responder receives a message, it performs the indicated operation on the user data base and returns a reply message to the sender.

If your physical link is	Then
a network link	the communication modules automatically take care of this layer.
a DF1 link between Allen-Bradley interface modules	the interface modules automatically take care of this layer. (See figure below.)

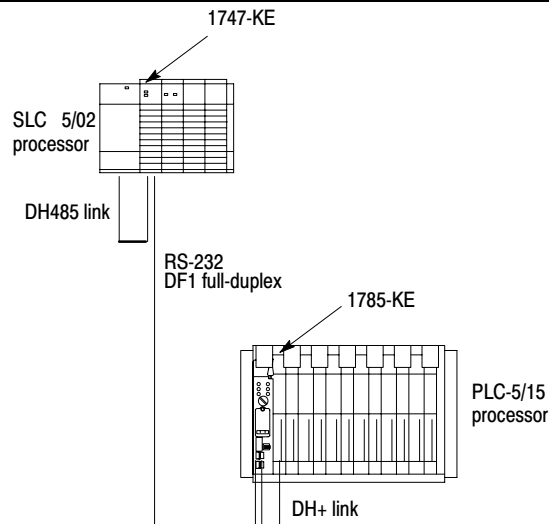

a DF1 link between an Allen-Bradley interface module and a computer	you will need to program this layer at your computer.
---	---



Messages

See Chapter 7, “Communication Commands,” for:

- a description of the command messages for each type of PLC processor
- information on how to program the application layer fields of a message packet for an asynchronous link

Message Packet Structure

All messages on a network have the same fundamental structure, regardless of their function or destination. If you could freeze a message packet while it is in transmission, you would see:

Bytes	Contents
protocol	Information used by the application and data-link layers of your software to get the message to its destination: <ul style="list-style-type: none"> • If a transaction originates from a PLC processor, the interface module automatically fills the protocol bytes. • If the transaction originates from a computer, your computer software must supply the necessary protocol.
data	Information supplied by application program at the source and delivered to the application program at the destination.

The following sections describe bytes that you define using the application-layer protocol bytes in your message packet.

For a detailed description of how to use these bytes for each type of command, see Chapter 7, “Communication Commands.”

To define this	See this page
command and reply message	1-9
message priority	1-10
delivery order of commands	1-10
types of commands	1-11
error codes	1-11

Command and Reply Message

A network transaction consists of a **command** and a **reply**.

The two parts provide extra data integrity by making sure that a required action always returns a reply with some sort of status, either zero status for a good reply, or non-zero status as an error code.

The application-layer protocol distinguishes a command from a reply. The data area of a command and its corresponding reply depend on the type of command.

Message Priority

You specify the priority level for each DH command in the message command code. The node that receives a command message must establish the same priority level for its corresponding reply message:

This link	Classifies a message as
DH	high priority or normal priority Priority levels of messages determine the order in which nodes transmit messages on a DH link. In the polling process, nodes with high priority messages will always be given priority over nodes with normal priority messages.
DH+	normal priority
DH485	normal priority

Important: Nodes with high priority messages are given priority over nodes with normal priority messages throughout the command/reply message cycle. For this reason, a command should be given a high priority designation only when special handling of specific data is required. Using an excessive number of high-priority commands defeats the purpose of this feature and could delay or inhibit the transmission of normal priority messages.

Delivery Order of Commands

The sending node, the network, and the receiving node execute commands based on network conditions, including—but not limited to:

- nodes buffering commands
- retries due to noise on the network
- priority levels

If your application requires that commands be delivered in a specific order, your logic must control the initiation of one command at a time on the network and verify delivery before initiating additional commands. This verification is completed by:

- a done bit or an error bit in a PLC processor
- a reply message in a computer

A done bit or a successful reply causes the next command to be initiated. If an error bit or a reply with non-zero status is returned, you must decide the appropriate action based on your application.

Important: If any node on the network initiates multiple commands (for example, the sending node sets multiple bits at any one time), the order in which these commands get executed at the receiving node cannot be guaranteed.

Types of Commands

From your computer on a DF1 link to a node on a DH, DH+ or DH485 link, you can send four types of commands:

- read
- write
- diagnostic
- upload/download

For additional information on the commands you can send, see Chapter 7, “Communication Commands.”

Error Codes

When your computer sends a command on the asynchronous link, a status code is returned in the reply message. This code tells you the status of the command sent from your computer. You must program your computer to interpret this code. For more information on codes and their meanings, see Chapter 8, “Message Packet Status Codes.”

Error codes can be generated at two places:

- the sending node
- the receiving node

For codes that are returned from the sending node:

From this node	Error codes are generated when
sending node	<ul style="list-style-type: none"> • an application program used the wrong message format or issued illegal commands. • the sending node cannot complete a transaction due to network problems.
receiving node	<p>an application problem exists at the receiving node. Typically, these involve:</p> <ul style="list-style-type: none"> • the PLC processor being off line (in Program mode, for example) or • the command trying to access a memory area is blocked by the interface module or user application program (i.e., the data table location does not exist or is restricted).

■ Protocol

Understanding DF1 Protocol — Chapter 2

Using Half-duplex Protocols to Send and Receive Messages — Chapter 3

Using Full-duplex Protocols to Send and Receive Messages — Chapter 4

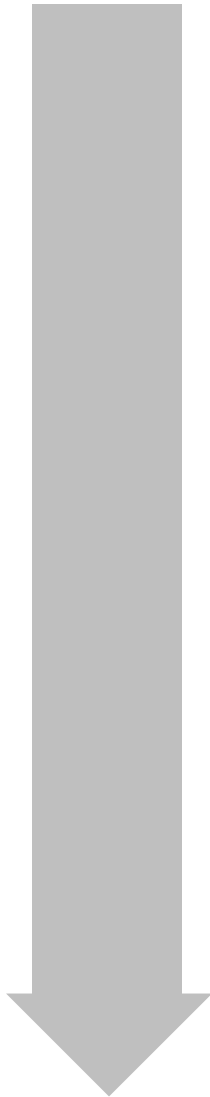

Understanding DF1 Protocol

If you are connecting an interface module to a computer, you must program the computer to understand and issue the proper protocol character sequences. This chapter describes the DF1 protocol you can use with your DF1-link driver for:

- peer-to-peer (two-way simultaneous) communication
- master-slave (two-way alternate) communication

This chapter includes these sections:

Section	Page
DF1 Protocol	2-2
Character Transmission	2-5
Transmission Symbols	2-6

Important: The 1784-KT and 1784-KT2 cards connect directly to DH+; the 1784-KR card connects directly to DH-485. As a result, an asynchronous RS-232 interface is not used and the information in this chapter does not apply to software written for these cards, which use the Standard Driver software.

DF1 Protocol

A **link protocol** is a set of programming rules for interpreting the signals transmitted over a physical link. A protocol, such as DF1:

- carries a message, error free, from one end of the link to the other

It has no concern for the content of the message, the function of the message, or the ultimate purpose of the message.

For example, with full-duplex DF1 protocol, it accomplishes this by attaching a check character (BCC) or check characters (CRC) to the end of each command and reply. The device receiving the command or reply then verifies the BCC or CRC and returns an ACK—if the BCC or CRC is acceptable—or an NAK—if the BCC or CRC does not check.

- indicates failure with an error code

Internally, the link protocol must delimit messages, detect and signal errors, retry after errors, and control message flow.

DF1 protocol is an Allen-Bradley data-link layer protocol that combines features of subcategories D1 (data transparency) and F1 (two-way simultaneous transmission with embedded responses) of ANSI x3.28 specification. There are two categories of DF1 protocol:

- half-duplex protocol (master-slave communication)
- full-duplex protocol (peer-to-peer communication)

Half-duplex Protocol

Half-duplex protocol is a multidrop protocol for one master and one or more slaves. With half-duplex protocol, you can have 2 to 255 nodes simultaneously connected on a single link; this link operates with all nodes interfaced through half-duplex modems. (For a list of devices that can be used as masters and slaves, see page 3-2. For more on half-duplex protocol, refer to Chapter 3, “Using Half-duplex Protocol to Send and Receive Messages.”)

To implement half-duplex protocol, use the following communication characteristics:

- 8 bits per character
- no parity
- 1 stop bit



Using half-duplex protocol

When you use half-duplex protocol, the intended environment is a multidrop link with all nodes interfaced through half-duplex modems. Unless there is only one slave directly connected to a master, you must use a modem. Your modems must support these signals:

- request-to-send (RTS)
- clear-to-send (CTS)
- data-carrier-detect (DCD)
- data-set-ready (DSR)
- data-terminal-ready (DTR)

If your modem does not support the DCD and DSR signals, you must jumper DCD and DSR to DTR.

You designate one node as **master** to control which node has access to the link. All other nodes are **slaves**, and must wait for permission from the master before transmitting. Each slave node has a unique node number between 0 and 254 (decimal).

The master can send and receive messages to and from each node on the multidrop link and to and from every node on network links connected to the multidrop link.

If the master is programmed to relay messages, then nodes on the multidrop link can engage in virtual slave-to-slave communication. This communication is transparent to the application.

Multiple masters are not allowed, except when one acts as a backup to the other and does not communicate unless the primary is shut down.



Slave-to-slave communication

In slave-to-slave communication, the master looks at the packet received from the slave. If the packet is not for the master, the master reassembles the packet as a master packet and sends the packet to slave devices.

Full-duplex Protocol

Use full-duplex protocol:

- over a point-to-point link that allows two-way simultaneous transmission
- over a multidrop link where interface modules are able to arbitrate transmission on the link
- for high performance applications where it is necessary to get the highest possible throughput from the available medium

If you connect an interface module to another Allen-Bradley communication interface module, the modules automatically handle the link arbitration. (For a list of modules that automatically handle link arbitration, refer to page 4-1.)



Full-duplex dial-up modems

Full-duplex dial-up modems can be used as long as a carrier is detected before the carrier timeout (about 10 seconds). If a carrier is not sensed before the timeout, the module drops DTR to trigger the modem to hang up the phone. A carrier must be sensed at least every 10 seconds to maintain the connection.

Character Transmission

Allen-Bradley interface modules send data **serially** over the RS-232-C/RS-422-A interface, one 10-bit byte—11-bit byte with parity—at a time. The transmission format conforms to ANSI X3.16, CCITT V.4, and ISO 1177 standards, with the exception that the parity bit is retained while the data length is extended to eight bits. Make sure that your computer conforms to this mode of transmission. The transmission format is:

No Parity

- start bit
- data bit 0
- data bit 1
- data bit 2
- data bit 3
- data bit 4
- data bit 5
- data bit 6
- data bit 7
- one stop bit

With Parity

- start bit
- data bit 0
- data bit 1
- data bit 2
- data bit 3
- data bit 4
- data bit 5
- data bit 6
- data bit 7
- even parity bit
- one stop bit

For all DH, DH+, and DH485 interface modules, you must comply with this transmission format. For communication rates and parity settings, refer to your module's user manual.

Transmission Symbols

Both half-duplex and full-duplex protocols are character-oriented. They use the ASCII control characters in the tables below, extended to eight bits by adding a zero for bit 7:

Table 2.A
Half-duplex Protocol

Abbreviation	Hexadecimal Value	Binary Value
STX	02	0000 0010
SOH	01	0000 0001
ETX	03	0000 0011
EOT	04	0000 0100
ENQ	05	0000 0101
ACK	06	0000 0110
DLE	10	0001 0000
NAK	0F	0000 1111

Table 2.B
Full-duplex Protocol

Abbreviation	Hexadecimal Value	Binary Value
STX	02	0000 0010
ETX	03	0000 0011
ENQ	05	0000 0101
ACK	06	0000 0110
DLE	10	0001 0000
NAK	0F	0000 1111

(For the standard definition of these characters, refer to the ANSI X3.4, CCITT V.3, and ISO 646 standards.)

A **symbol** is a sequence of one or more bytes having a specific meaning to the link protocol. The component characters of a symbol must be sent one after another with no other characters between them. DF1 protocol combines the characters listed in the tables above into control and data symbols:

- Control symbols are fixed symbols required by the DF1 protocol to read a particular message
- Data symbols are variable symbols which contain the application data for a particular message

Table 2.C
Half-duplex Transmission Symbols

Symbol	Type	Meaning
DLE SOH	control symbol	Sender symbol that indicates the start of a master message.
DLE STX	control symbol	Sender symbol that separates the multi-drop header from the data.
DLE ETX BCC/CRC	control symbol	Sender symbol that terminates a message.
DLE ACK	control symbol	Response symbol which signals that a message has been successfully received.
DLE NAK	control symbol	Global link reset command only issued by the master. Causes the slaves to cancel all messages that are ready to transmit to the master. Typically, the slave returns the message and an error code to the originator.
DLE ENQ	control symbol	Sender symbol, issued only by the master, that starts a poll command.
DLE EOT BCC	control symbol	Response symbol used by slaves as a response to a poll when they have no messages to send.
STN	data symbol	Station number of the slave node on your half-duplex link.
APP DATA	data symbol	Single characters having values 00-0F and 11-FF. Includes data from application layer including user programs and common application routines. A data 10 ₁₆ is sent as 10 10 (DLE DLE).
DLE DLE	data symbol	Represents the data value or STN value of 10 ₁₆ . See APP DATA.

Table 2.D
Full-duplex Transmission Symbols

Symbol	Type	Meaning
DLE STX	control symbol	Sender symbol that indicates the start of a message frame.
DLE ETX BCC/CRC	control symbol	Sender symbol that terminates a message frame.
DLE ACK	control symbol	Response symbol which signals that a message frame has been successfully received.
DLE NAK	control symbol	Response symbol which signals that a message frame was not received successfully.
DLE ENQ	control symbol	Sender symbol that requests retransmission of a response symbol from the receiver.
APP DATA	data symbol	Single character data values between 00-0F and 11-FF. Includes data from application layer including user programs and common application routines. A data 10 ₁₆ is sent as 10 10 (DLE DLE).
DLE DLE	data symbol	Represents the data value of 10 ₁₆ .

Using Half-duplex Protocols to Send and Receive Messages

In half-duplex protocol, devices share the same data circuits, therefore only one device can “talk” at a time. Half-duplex protocol can be likened to a one-lane bridge: each car must wait its turn to cross the bridge. (To compare half-duplex to full-duplex protocol, refer to Chapter 4, “Using Full-duplex Protocols to Send and Receive Messages.”)

Read this chapter to help learn how to use half-duplex protocol to send and receive messages. It contains these sections:

Section	Page
Half-duplex Protocol Message Transmission	3-2
Transmitter and Receiver Message Transfer	3-3
Half-duplex Protocol Environment	3-3
Message Characteristics	3-7
Master Polling Responsibilities	3-7
Slave Transceiver Actions	3-9
Half-duplex Protocol Diagrams	3-11

Half-duplex Protocol Message Transmission

Half-duplex protocol:

- is a multidrop protocol for one master and one or more slaves
- provides a lower data throughput than full-duplex
- allows communication with each node on the multidrop link
- allows communication with nodes on links connected to the multidrop link

If the master is programmed to relay messages, then nodes on the multidrop can engage in virtual slave-to-slave transfers. Half-duplex protocol operates on a multidrop link with all nodes interfaced through half-duplex modems. There may be from 2 to 255 nodes simultaneously connected to a single link.

In half-duplex mode, one node is designated as **master** and it controls which node has access to the link. All other nodes are called **slaves** and must wait for permission from the master before transmitting. Allen-Bradley devices with master and slave capabilities include:

Devices with master capability	Devices with slave capability
• SLC 5/03 and 5/04 (on channel 0) ^①	• 1747-KE
• 1771-KGM DH SCADA Master module	• 1770-KF2, -KF3, -KFC
• 5130-RM1, -RM2, -KA (channel 1)	• 1775-KA (via modem port)
• 5130-RM2	• 1785-KE
• a user-programmed intelligent device	• 1771-KE, -KF, -KG
• a personal computer running ControlView software	• PLC-5/11 -5/20, -5/30, -5/40, -5/60, PLC-5/80 (on channel 0)
• PLC-5/11 -5/20, -5/30, -5/40, -5/60, PLC-5/80 (on channel 0)	• SLC 5/03 and 5/04 (on channel 0)
• personal computer running WINtelligent™ LINX™ software	• 5130-RM1, -RM2, -KA (channel 1)
• personal computer running RSLINX™	• personal computer running WINtelligent™ LINX™ software
	• personal computer running RSLINX™

^① SLC 5/03 and 5/04 processors (OS302 and OS401, respectively) now support half-duplex DF1 masters.

With half-duplex protocol, you can use a:

- **two-circuit system** – master sends and slaves receive on one circuit, slaves send and master receives on the other
- **one-circuit system** – master and slaves send and receive on the same circuit

Transmitter and Receiver Message Transfer

Each node on a multidrop link contains a software routine to transmit and receive messages. DH and DH+ interface modules already contain a slave transceiver routine, so they can be configured to function as slave nodes in half-duplex mode.

Instead of a single routine, you can program separate transmitter and receiver routines. However, in this chapter, we assume you are using a single routine. The master and slave transmitter/receivers are illustrated in the figure below:

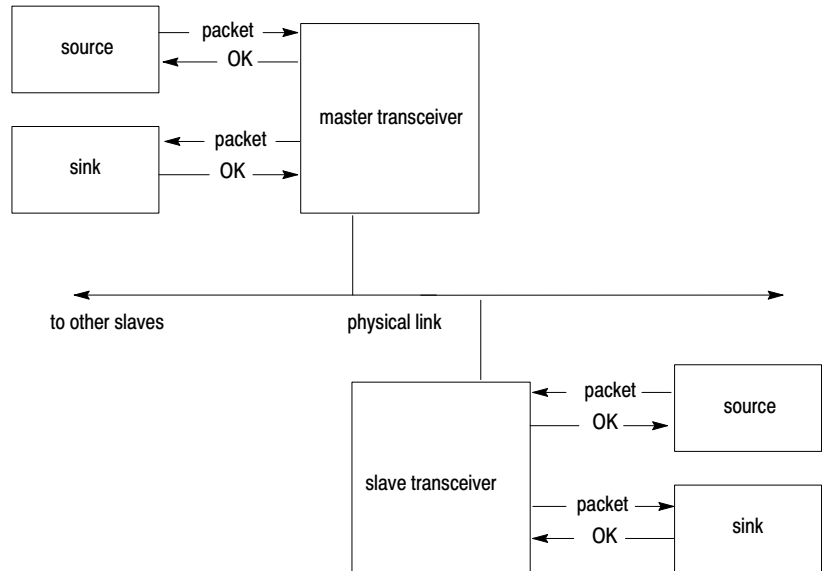

(The “source” and “sink” are defined in the next section, “Half-duplex Protocol Environment.”)

Half-duplex Protocol Environment

To define the environment of the protocol, the transceiver:

- needs to know where to get the message it sends, the **message source**. We assume the message source:
 - supplies one message at a time upon request from the transceiver
 - requires notification of the success or failure of the transfer before supplying the next message
- must have a means of disposing of messages it receives, the **message sink**

When the transceiver has received a message successfully, it attempts to give it to the message sink. If the message sink is full, the transceiver will receive an indication that the sink is full.

The following program describes the actions of the transceiver in detail:

```

TRANSCIEVER is defined
variables
  LAST-HEADER is 4 bytes copied out of the last good message
  BCC is an 8-bit block check accumulator
  LAST-HEADER = invalid
loop
  reset parity error flag
  GET-CODE
  if it's a DLE SOH then
    begin
      GET-CODE
      if it's a data code and it matches the station number or it
        is 255 (the broadcast address) then
          begin
            BCC = the data code
            GET-CODE
            if it's a DLE STX then
              begin
                RESPONSE = GETMESSAGE
                if RESPONSE is ACK then
                  begin
                    if message header is different from
                      last and sink is not full
                      begin
                        save new HEADER
                        try to send message to sink
                      end
                    if this is not a broadcast message
                      and sink was not full then
                      begin
                        turn on RTS
                        wait for CTS
                        send DLE ACK
                        turn off RTS
                      end
                    end
                  end
                end
              end
            end
          end
        end
      end
    end
  else if it's a DLE ENQ then
    begin
      GET-CODE (the station number)
      GET-CHAR (the BCC)
      check the station number and the BCC, and if they're OK then
        begin
          if there is a message left over from the last time and
            the transmit counter is exceeded then
            throw the message away and send an error code to the
              message source
          if there is no message then
            try to get one from the message source
          turn on RTS
          wait for CTS
          if there is still no message then send a DLE EOT
          else SEND the message
          turn off RTS
        end
      end
    end
  else if it's a DLE ACK then
    send a success code to the message source and discard the
      message
  else if it's a DLE NAK then
    while the message source can supply a message
      begin
        get a message from the message source
        discard the message
        send an error code to the message source
      end
    end
  end
end

```

GETMESSAGE is defined as

```

GET-CODE
while it is data code
  begin
    if buffer is not overflowed put data in buffer
    GET-CODE
  end
if it is a control code and it is an ETX then
  begin
    if parity error flag is set then return a NAK
    if BCC is not zero then return a NAK
    if message is too small then return a NAK
    if message is too large then return a NAK
    return an ACK
  end
else end

```

GET-CODE is defined as

```

loop
  variable
  GET-CHAR
  if char is not a DLE
    begin
      add char to BCC
      return the char and a data flag
    end
  else
    begin
      GET-CHAR
      if char is a DLE
        begin
          add char to BCC
          return a DLE and a data flag
        end
      else if char is an ETX
        begin
          GET-CHAR
          add char to BCC
          return ETX with a control flag
        end
      else return char with a control flag
    end
  end
end

```

GET-CHAR is defined as

an implementation-dependent function that returns one byte of data from the link interface hardware

SEND (Message) is defined as

```

begin
  BCC = 0
  send DLE STX
  for every byte in the message do
    begin
      subtract the byte from the BCC
      send the corresponding data code
    end
  send DLE ETX BCC
end

```

The following flowchart shows the software logic for implementing half-duplex protocol from the master node's point of view:

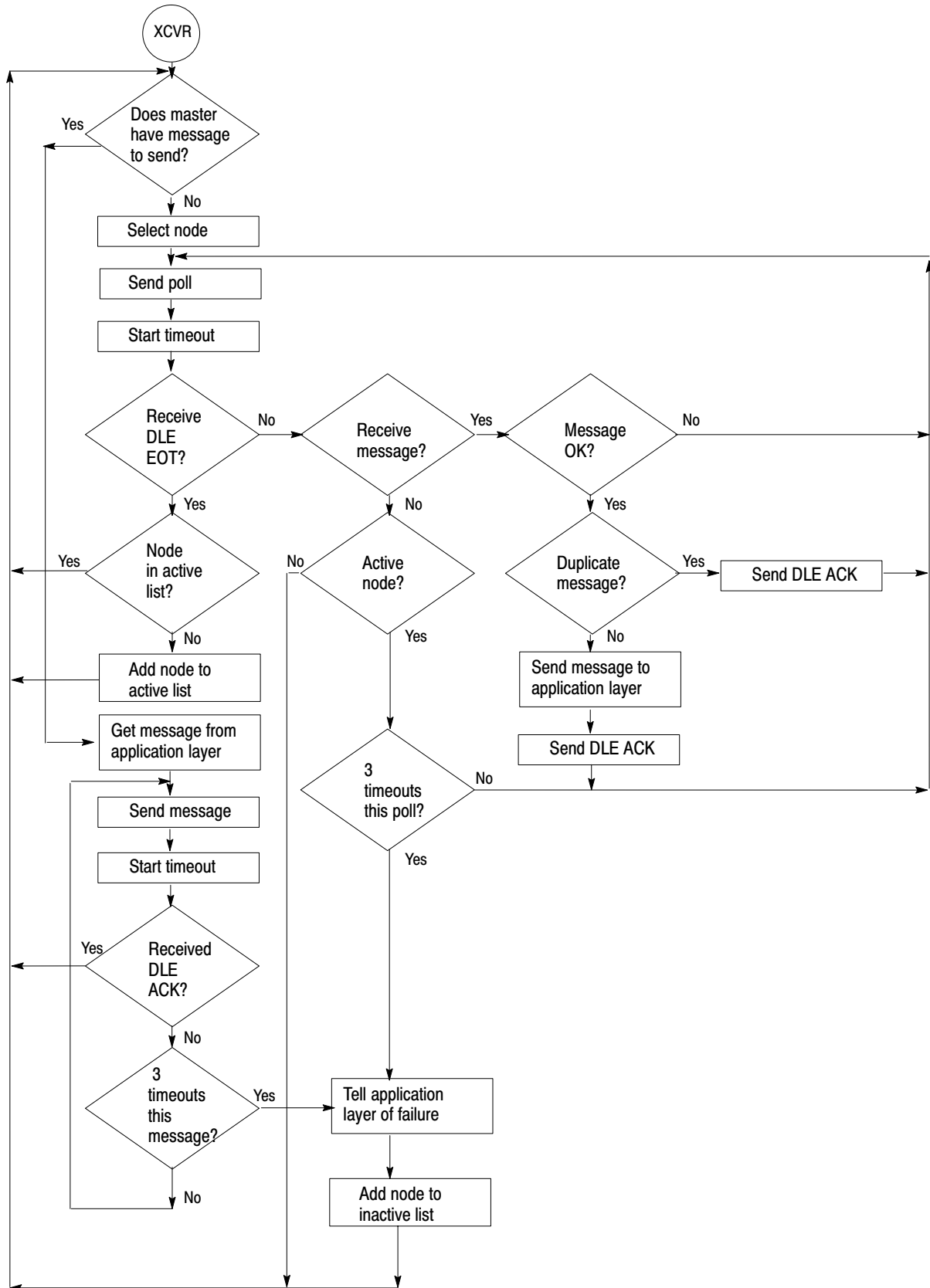

Message Characteristics

Ideally, the data-link layer protocol is not concerned with the content or form of the messages it is transferring. However, half-duplex protocol places the following restrictions on the messages that are submitted to it for transfer:

- Minimum size of link-layer data is 6 bytes
- Maximum size of link-layer data depends on the application-layer command
- Some protocol implementations require that the first byte of a message match the node address; thus, receivers ignore messages that do not contain the correct address. This filtering can optionally be performed by the message sink.
- As part of the duplicate message detection algorithm, the receiver checks the source (SRC), command (CMD), and transaction (TNS) fields of each message. There must be a difference in at least one of these bytes between a message and the previous message. Otherwise, the message is classified as a retransmission of the previous message. (For more information on these fields, see pages NO TAGNO TAG and NO TAG.)

Master Polling Responsibilities

The master polling algorithm varies depending on the expected flow of traffic through the system. A simple master continuously polls each slave in “round-robin” fashion. If a message is received, it is handled, then the next node is polled. In addition to general responsibilities, masters are responsible for:

- detecting duplicates
- polling inactive slaves
- relieving full sinks
- using simplified network layer
- slave-to-slave message relaying

Duplicate Detection

Duplicate detection information must be kept for each node, unless the master polls each node repeatedly until it is empty, before proceeding to the next. Then, duplicate detection information only needs to be kept for the current node.

Inactive Slave Polling

If a slave fails to respond to a poll, the master removes the slave from the list of active slaves. To save time, the master polls the active slaves on a regular basis, and polls the inactive slaves occasionally to see if they respond. When an inactive slave does not respond to a poll, it is put back into the active slave list.

Full Sinks

When a node times out to a message command, poll the node to see if it responds. If it responds to the poll with a DLE EOT but consistently fails to ACK a message, its sink is probably full. You must wait for the buffers to clear before sending another message.

Buffer-full condition

Some devices hold data indefinitely. To get the data and relieve the buffer-full condition, you must poll the device.

When a node's message source and sink share a common memory pool, an abundance of messages in the message source may cause a message sink full indication. In this case, the master can poll the node to receive messages and make memory available. Waiting for the memory to clear on its own may not work on all devices; the only way to free memory is to have the master poll the node.

Simplified Network Layer

To allow peer-to-peer communication on the multidrop, your master must use a simplified network layer. This network layer resides just above the data-link layer and performs routing and relaying of messages. (For more on the network layers, refer to Chapter 1, "Network Layers.")

Slave Transceiver Actions

Since input sent to the transceiver can often be affected by noise from the physical world, the transceiver must be capable of responding to many adverse situations, such as:

- The message sink can be full, leaving nowhere to put a message
- A message can contain a parity error
- The BCC/CRC can be invalid
- The DLE SOH, DLE STX, or DLE ETX BCC/CRC may be missing
- The message can be too long or too short
- A spurious control or data symbol can occur outside a message
- A spurious control symbol can occur inside a message
- The DLE ACK response can be lost, causing the transmitter to send a duplicate copy of a message that has already been passed to the message sink

Waits for message

The slave is always in a passive mode until it receives a message. While waiting for a message, any message other than the DLE SOH or DLE ENQ is ignored. (In a single circuit system, the slaves must be able to safely ignore everything sent by other slaves.)

Receives message

If a DLE SOH is received, the BCC/CRC and the message buffer are reset. The next symbol received must be a data symbol and must equal the node address (or 255 if the node can receive broadcast messages):

If the node address and the symbol	Then
do not match	the node ignores the rest of the message and continues waiting for the start of the message
match	it is added to the BCC/CRC

The next symbol is received and must match the DLE STX; if the symbol address doesn't match, the node ignores the rest of the message, and the symbol starts building a message.

Builds a message

While building a message, all data symbols are stored in the message buffer and added to the accumulated BCC/CRC. The slave sets an error flag to indicate the occurrence of a parity, buffer overrun, message framing, or modem handshaking error.

Verifies DLE ETX BCC/CRC

If any control symbol other than a DLE ETX BCC/CRC is received at the end of the packet, the message is discarded and all input is ignored until the next DLE SOH or DLE ENQ is received. When the DLE ETX BCC/CRC is received, the error flag, the BCC/CRC, the message size, and the address (optionally) are all verified:

If DLE ETX BCC/CRC content is	Then the
incorrect	message is ignored
correct	slave begins the duplicate message detection process

Performs duplicate detection

The slave compares the SRC, CMD, and both TNS bytes to the corresponding bytes of the previous message:

If these bytes are	Then the slave
the same	discards the current message and sends a DLE ACK.
different	tests the state of the message sink:
	<ul style="list-style-type: none"> • If the message sink is full, the transceiver discards the current message and does not respond • If the message sink is not full, the transceiver: <ul style="list-style-type: none"> • forwards the current link level data to the message sink • keeps a copy of the first four bytes of the current link-level data for duplicate message detection • sends a DLE ACK

Receives a poll

If, while waiting for a message, a poll (DLE ENQ STN BCC) is received, the transceiver accepts the next two characters. The last character is a BCC and is not byte stuffed. If the station address does not match or there is an error, the poll is ignored. If the poll is accepted, there are three possible situations:

- The transceiver could still be holding a message that it had transmitted previously, but had not been ACKed. There is a limit on the number of times each reply message can be sent:

If this limit is	Then
exceeded	when the poll is received, the reply message is returned to the message source with an error indication, and the transceiver tries to send the next message from the message source.
not exceeded	the response to the poll is to re-send the current reply message

- If no message is currently being held, the transceiver tries to get one from the message source:

If	Then
a message is available	the transceiver initializes its re-try counter and transmits it in response to the poll
no message is available	the response to a poll is to transmit a DLE EOT

Transmits a message	When a message is transmitted after receiving a poll, its format is identical to a full-duplex message packet. After sending a message, the transceiver holds the message until a DLE ACK is received, or the number of times the message has been polled exceeds the limit.
Receives DLE ACK	When a DLE ACK is received, the message currently held is discarded and the message source is notified of a successful delivery. When the next poll is received the next message available from the message source is sent (or a DLE EOT).
Receives DLE NAK	When a DLE NAK is received, the transceiver takes messages from the source until it is empty. Each message is discarded with an error code sent back to the message source. This can be used by the master to clear up the message source buffers of all slaves after the master has been down.

Half-Duplex Protocol Diagrams

The following figures show events that occur on various interfaces. Link-layer data bytes are represented by “xxxx” and corrupted data is represented by “???”.

These figures show the steps that occur on the data-link layer when a single command message packet is sent; they do not show the steps involved when the receiving node returns a reply message packet.

For this transfer	See page
normal message transfer	3-12
message transfer with invalid BCC	3-12
message transfer with ack destroyed	3-13
poll with no message available	3-13
poll with message returned	3-14
duplicate message transmission	3-15
message sink full, case 1	3-16
message sink full, case 2	3-17

Normal Message Transfer

In this transfer:

- data bytes are sent from the source to the master and transmitted to a slave
- the sink sends a “not full” message
- the data is sent to the sink and a DLE ACK is sent to the master
- the master tells the source that the message was delivered

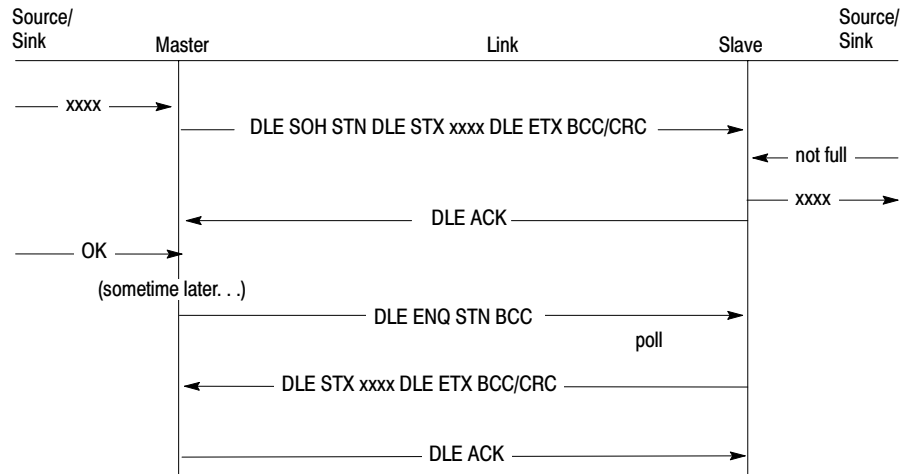

Message Transfer with Invalid BCC/CRC

In this transfer:

- the master sends a message with an invalid BCC/CRC
- the master receives no ACK and times out
- the master retransmits with a valid BCC/CRC and proceeds with a normal message transfer

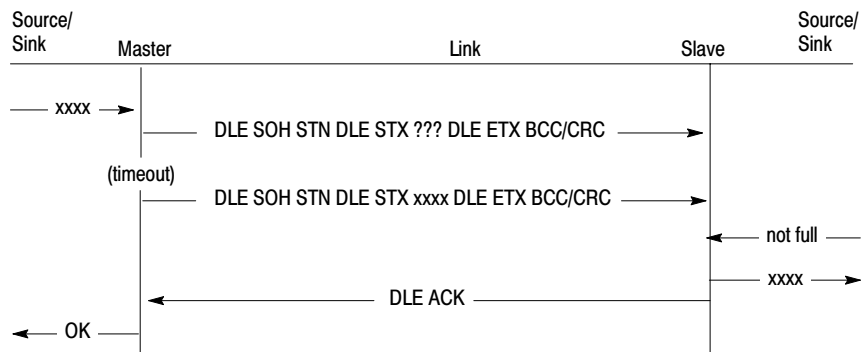

Message Transfer with ACK Destroyed

In this transfer:

- the master sends a message
- the slave accepts the message and returns a DLE ACK, but the DLE ACK is destroyed
- the master re-transmits and proceeds with a normal message transfer
- If duplicate detect is enabled, the duplicate message is discarded

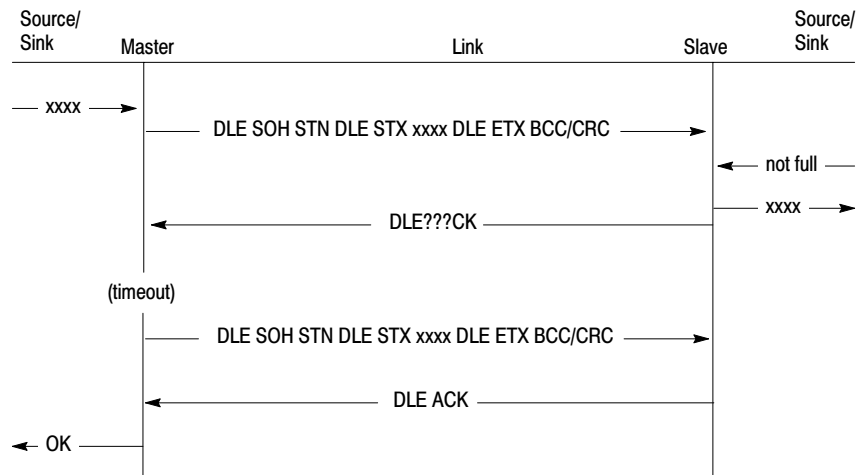

Poll with No Message Available

In this transfer:

- the master polls the slave for a message
- the slave has no message
- the slave returns a DLE EOT

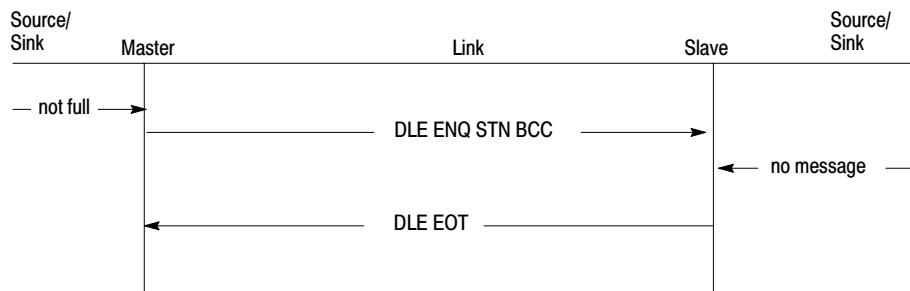

Poll with Message Returned

In this transfer:

- the master polls for a message and the slave returns a message with faulty data
- since it did not receive a DLE ACK on its first attempt, the slave re-transmits the same message
- the master responds with a DLE ACK

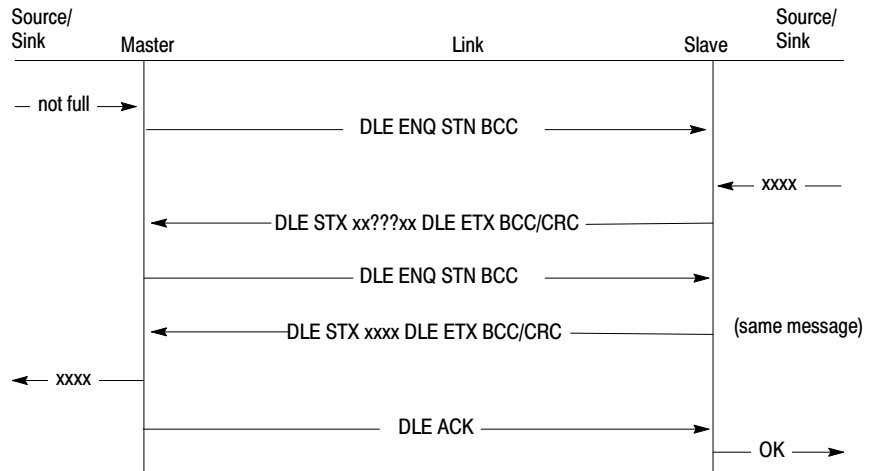

Duplicate Message Transmission

In this transfer:

- a slave does not receive a DLE ACK from the master after the master receives the slave's message
- when the master polls the slave again, the slave sends the same message
- the master sends a DLE ACK but discards the duplicate message

To implement duplicate message detection, the master must either:

- poll a node repeatedly (without polling any other node) until it receives a DLE EOT
- keep a record (if each node is polled only once per cycle) of the 4 link-layer data bytes of the last message packet sent by each slave node (since other nodes may transfer messages before a node retransmits). The master must buffer the entire reply until it can transmit the reply to the slave

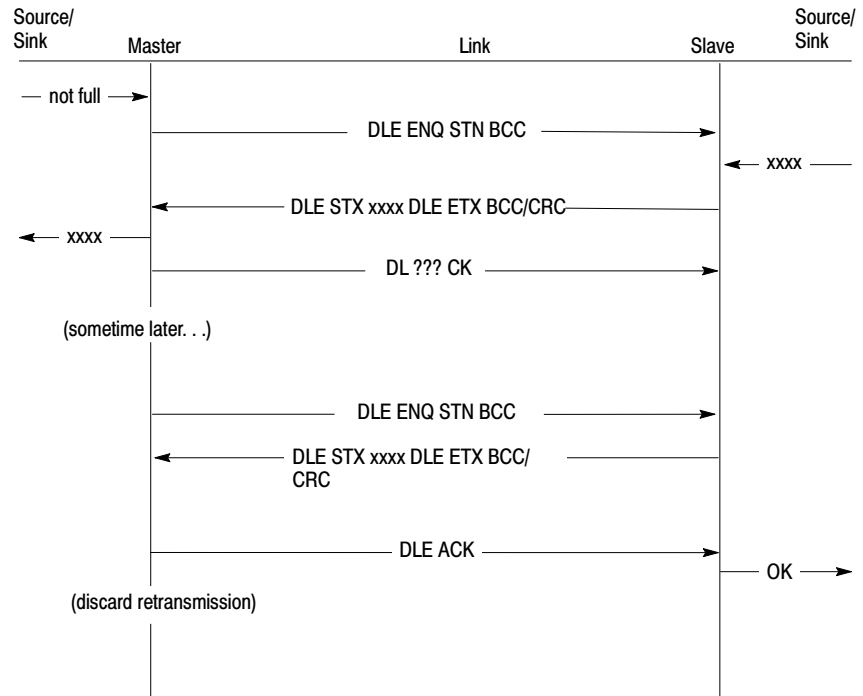

Message Sink Full, Case 1

In this transfer, the slave's message sink is full. If a slave does not respond to a command, then this might indicate that the slave's buffers are full. If the slave's buffers are full, then a poll by the master results in the slave transmitting a reply other than 1004 (DLE EOT).

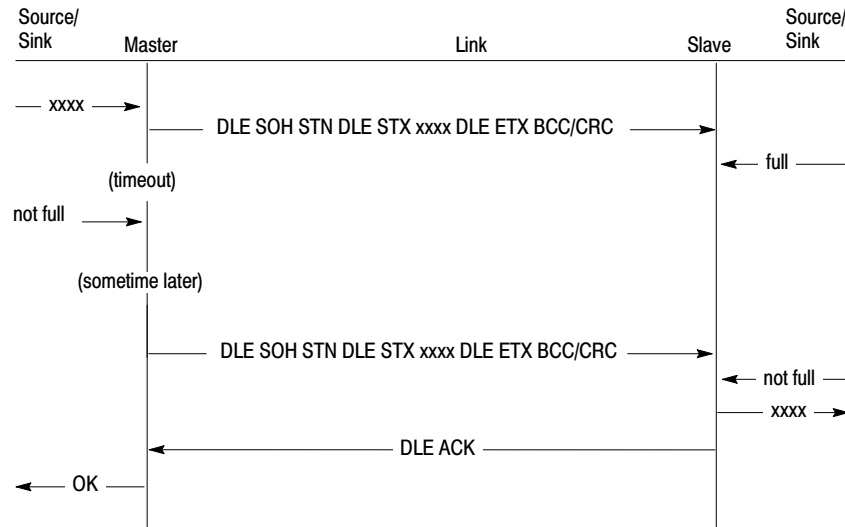

Message Sink Full, Case 2

In this transfer, the slave's message source and message sink share the same memory pool (as with the 1771-KG). The message sink is full because there are too many messages in the message source. To clear the message sink, the master must first receive messages from the slave's message source. Otherwise, the slave's sink will remain full.

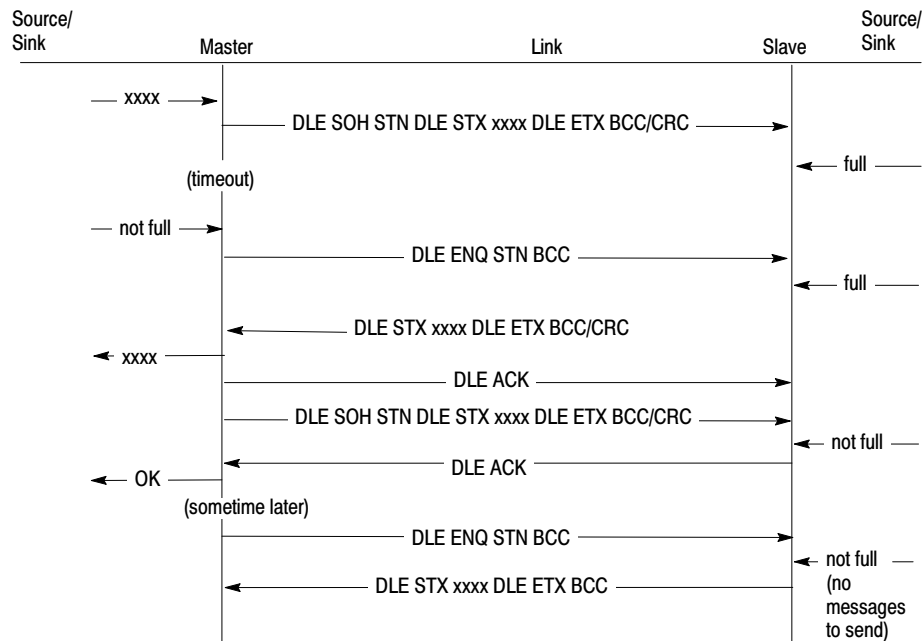

Using Full-duplex Protocol to Send and Receive Messages

In full-duplex protocol, devices share the same data circuits, and both devices can “talk” at the same time. Full-duplex protocol can be likened to a two-lane bridge: traffic can travel in both directions at one time. (To compare full-duplex to half-duplex protocol, refer to Chapter 3, “Using Half-duplex Protocols to Send and Receive Messages.”)

Read this chapter to help learn how to use full-duplex protocol to send and receive messages. It contains these sections:

Section	Page
Full-duplex Protocol Message Transmission	4-2
Full-duplex Protocol Environment	4-3
Message Characteristics	4-4
Transmitter and Receiver Message Transfer	4-4
Full-duplex Protocol Diagrams	4-10



Link arbitration

You can use these Allen-Bradley interface modules to automatically handle the link arbitration:

- 1747-KE
- 1770-KF2
- 1770-KF3
- 1770-KFC
- 1771-KE
- 1771-KF
- 1771-KG
- 5130-KA
- 1775-KA (via modem port)
- 1785-KE
- 5130-RM1 (channel one)
- 5130-RM2

Full-duplex Protocol Message Transmission

With full-duplex protocol, a link uses two physical circuits for two-way simultaneous message transmission (command or reply message packets). These two physical circuits provide communication on four logical paths:

Figure 4.1
Data paths for two-way simultaneous operation

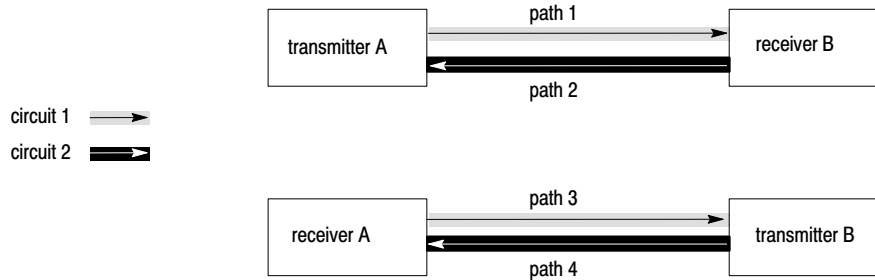

- On the **first circuit**, transmitter A sends messages to receiver B (path 1) and receiver A sends response control symbols (DLE ACK, DLE NAK) to transmitter B (path 3).
- On the **second circuit**, transmitter B sends messages to receiver A (path 4) and receiver B sends response control symbols (DLE ACK, DLE NAK) to transmitter A (path 2).
- All message and symbols on the first circuit are traveling in the same direction (node A to node B) and all messages and symbols on the second circuit are traveling in the opposite direction (B to A).

Figure 4.2
Software implementation of data paths

Paths 1, 2, 3, and 4

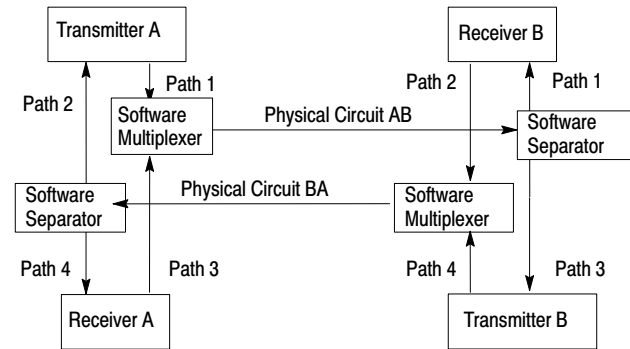

Paths 1 (a message symbol sent from node A to node B)

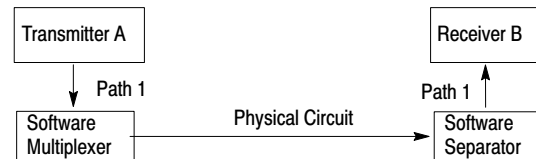

- To implement four logical paths with two physical circuits, a software multiplexer is needed to combine the message symbols with the response symbols going in the same direction.
- At the other end of the link, a software separator divides the message symbols from the response symbols. The internal software sends the message symbols to the appropriate receiver, and the response symbols to the appropriate transmitter.
- Although message symbols and response symbols on the same circuit operate independently of each other, there is some interaction.
- For example, a message on physical circuit AB will be delayed if a response symbol from receiver A is inserted in a stream of message symbols from transmitter A (embedded response).
- Also, any hardware problems that affect message symbols traveling over a circuit will also affect response symbols on the same circuit.

Full-duplex Protocol Environment

To define the environment of the protocol:

- the transmitter needs to know where to get the message it sends, the **message source**. We assume the message source:
 - supplies one message at a time upon request from the transmitter
 - requires notification of the success or failure of the transfer before supplying the next message
- the receiver must have a means of disposing of messages, the **message sink**

If the	Then the
message source is empty	transmitter waits in an inactive state until a message is available
receiver has received a message successfully	receiver attempts to give it to the message sink. If the message sink is full, the receiver must be notified

Figure 4.3 shows the protocol environment for message symbols from transmitter A to receiver B (path 1) and response codes from receiver B to transmitter A (path 2).

Figure 4.3
Protocol Environment

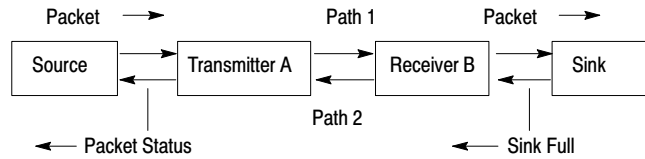

Message Characteristics

Ideally, the data-link-layer protocol is not concerned with the content or form of the message packet (link-layer data) it is transferring. However, full-duplex protocol places the following restrictions on link-layer data submitted to it for transfer:

- minimum size of valid link-layer data is 6 bytes
- maximum size of valid link-layer data depends on the application-layer command
- some protocol implementations (e.g., point-to-point links to a 1771-KG module) require that the first byte of the link-layer data match the node address

The receiver ignores messages that do not contain the correct address.

- as part of the duplicate message detection algorithm, the receiver compares the second, third, fifth, and sixth bytes of the link-layer data with the same bytes in the previous message

If there is no difference between the sets of bytes, the message is classified as a re-transmission of the previous message. You can set some Allen-Bradley interface modules so that they do not implement duplicate-message detection.

Transmitter and Receiver Message Transfer

In full-duplex protocol, messages are sent from the **source** (part of software that supplies message packet) through a **transmitter** (device that sends data) and then a **receiver** (device that receives data) to the **sink** (part of the software that accepts the received data):

For	See page
structured text on how the transmitter operates	4-5
a flowchart of how the transmitter operates	4-6
structured text on how the receiver operates	4-7
a flowchart of how the receiver operates	4-9

How the Transmitter Operates

The following program describes the actions of the transmitter:

Whenever the message source can supply a message packet and the transmitter is not busy, it sends a frame on the link to the destination address. It then starts a timeout, and waits for a response.

When this response is received from the receiving address	The message packet
DLE ACK	has been successfully transferred. After signaling the message source that the message packet was successfully transmitted, the transmitter proceeds with the next message packet.
DLE NAK	is retransmitted. The transmitter restarts the timeout and waits again for a response. If it receives a DLE ACK, the transmitter starts a timeout. This can be repeated several times. You can set a limit to the number of times a message can be re-transmitted for each module. If this limit is exceeded, the message source is informed of the failure and the transmitter proceeds with the next message.

If the timeout expires before a response is received, the transmitter sends a DLE ENQ to request a retransmission of the last response. It restarts the timeout and waits for a response.

You can also set a limit to the number of timeouts that are allowed per message. If the enquiry (ENQ) limit is exceeded, the transmitter signals the message source that the transmission has failed, and the transmitter proceeds to the next message.

There are three responses defined: DLE ACK, DLE NAK, DLE ENQ, If the transmitter receives an different response, the transmitter ignores it.

```

TRANSMITTER is defined as
  loop
    Message=GET-MESSAGE-TO-SEND
    Status=TRANSFER(Message)
    SIGNAL-RESULTS(Status)
  end loop
  loop
    WAIT for response on path 2 or timeout.
    if received DLE ACK then return SUCCESS
    else if received DLE NAK then
      if nak-limit is exceeded then return FAILURE
    else
      begin
        count NAK re-tries;
        SEND-MESSAGE(message);
        start timeout
      end
    else if timeout
      if enq-limit is exceeded then return FAILURE
    else
      begin
        count ENQ re-tries;
        send DLE ENQ on path 1;
        start timeout
      end
    end loop
  SEND (message) is defined as
  begin
    BCC = 0
    send DLE STX on path 1
    for every byte in the message do
      begin
        add the byte to the BCC;
        send the corresponding data symbol
      on
        path 1
      end
    send DLE ETX BCC on path 1
  end
GET-MESSAGE-TO-SEND
  This is an operating-system-dependent interface
  routine that waits and allows the rest of the
  system to run until the message source has supplied
  a message to be sent.
SIGNAL-RESULTS
  This is an implementation-dependent routine that
  tells the message source of the results of the
  attempted message transfer.
WAIT
  This is an operating-system-dependent routine
  that waits for any of several events to occur
  while allowing other parts of the system to run.
TRANSFER (Message) is defined as
  initialize nak-limit and enq-limit
  SEND(Message)
  start timeout

```

The following flowcharts the software logic for implementing the transmitter:

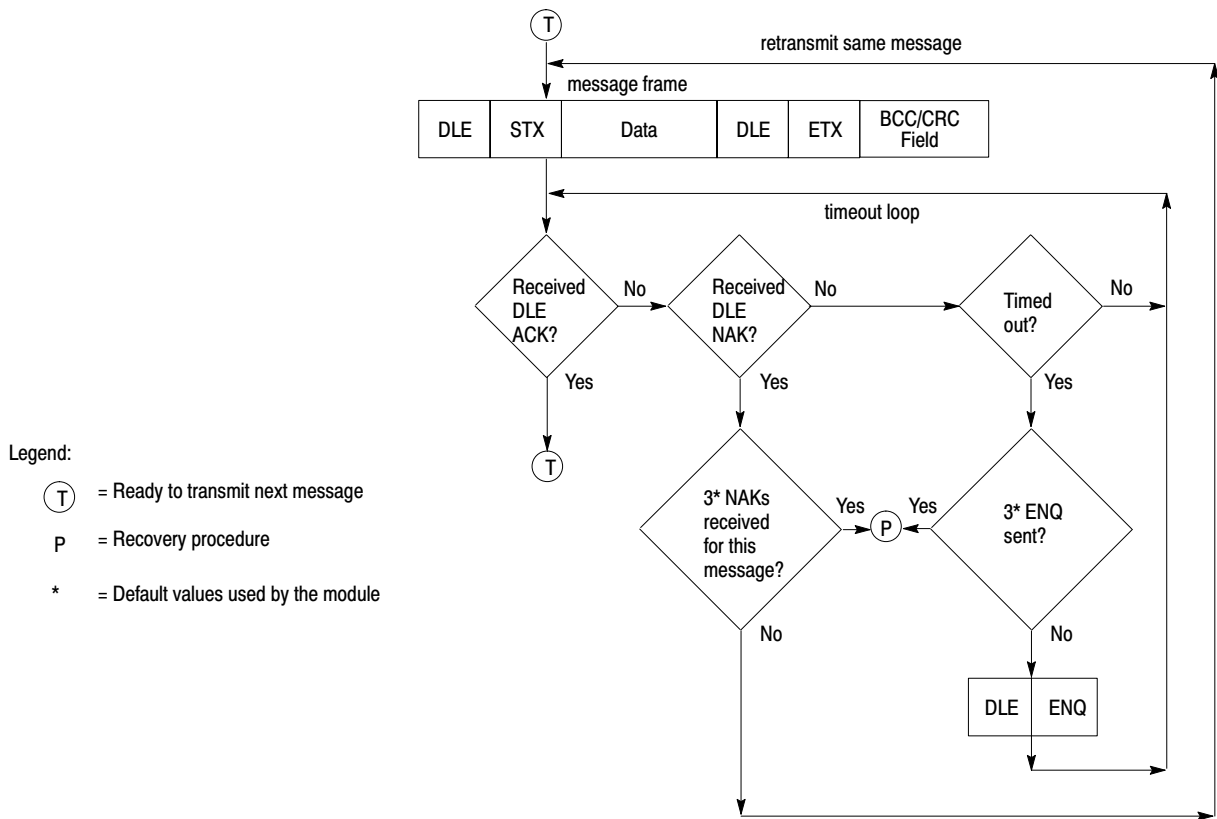

Important: Depending on network-link traffic and saturation level, you may need to wait for a reply from the remote node before transmitting the next message. Implement an option that allows users to choose the maximum amount of outstanding messages that can exist at one time; we suggest a selectable range of one to three messages.

How the Receiver Operates

The receiver must be capable of responding to adverse situations. Some of the problems that can occur are:

- the message sink is full, so the receiver has nowhere to put a message
- a message can contain a parity error
- the BCC or CRC can be invalid
- the DLE STX or DLE ETX BCC/CRC may be missing
- the message is too long or too short
- a false control or data symbol occurs outside a message
- a false control symbol occurs inside a message
- the DLE ACK response is lost, causing the transmitter to send a duplicate copy of a message already passed to the message sink

The following program describes the actions of the receiver in detail.

The receiver keeps a record of the last response sent to the transmitter. The value of this response is either DLE ACK or DLE NAK. It is initialized to DLE NAK. When a DLE ENQ (enquiry) is received from the transmitter, the receiver sends the value of the last response.

The receiver ignores all input until a DLE STX or DLE ENQ is received. If anything other than a DLE STX or DLE ENQ is received on path one, the receiver sets the last response variable to NAK.

When this symbol is received from the transmitter	Then the
DLE ENQ	last response is sent and the receiver continues waiting for input.
DLE ACK	BCC/CRC and the message buffer are reset, and the receiver starts building a reply message.

While building a reply message, all data symbols are stored in the message buffer and added to the BCC/CRC. If the buffer overflows, the receiver continues summing the BCC/CRC, but the data is discarded.

If a parity, overrun, framing, or modem handshaking error is detected, it is recorded .

If a control symbol other than DLE STX or DLE ETX is received, the message is aborted and a DLE NAK is sent to the transmitter. When DLE STX or DLE ETX is received, the error flag, the BCC/CRC, the message size, and the address (optionally) are all checked. If any of the tests fail, a DLE NAK is sent.

GET-CHAR is defined as an implementation-dependant function that returns one byte of data from the link interface hardware

```

RECEIVER is defined as
  variables
    LAST-HEADER is 4 bytes copied out of the last good message
    RESPONSE is the value of the last ACK or NAK sent
    BCC is an 8-bit block check accumulator
  LAST-HEADER = invalid
  LAST RESPONSE = NAK
  loop
    reset parity error flag
    GET-SYMBOL
    if DLE STX then
      begin
        BCC = 0
        GET-SYMBOL
        while it is a data symbol
          begin
            if buffer is not overflowed put
              data in buffer
              GET-SYMBOL
          end
        if the control symbol is not a DLE ETX then send DLE
        NAK
        else if error flag is set then send DLE NAK
        else if BCC is not zero then send DLE NAK
        else if message is too small then send DLE NAK
        else if message is too large then send DLE NAK
        else if header is same as last message send a DLE ACK
        else if message sink is full send DLE NAK
        else
          begin
            send message to message sink
            send a DLE ACK
            save a last header
          end
        end
      end
    else if DLE ENQ then send LAST-RESPONSE
    else LAST-RESPONSE = NAK
  end loop
GET-SYMBOL is defined as
  loop
    GET-CHAR
    if char is not DLE
      begin
        add char to BCC
        return the char and data flag
      end
    else
      begin
        GET-CHAR
        if char is a DLE
          begin
            add char to BCC
            return DLE and data flag
          end
        else if char is an ACK or NAK send it to the transmitter
        else if char is an ETX
          begin
            GET-CHAR
            add char to BCC
            return ETX with a control flag
          end
        else return char with a control flag
      end
    end loop

```

The following flowchart is the software logic for implementing the receiver.

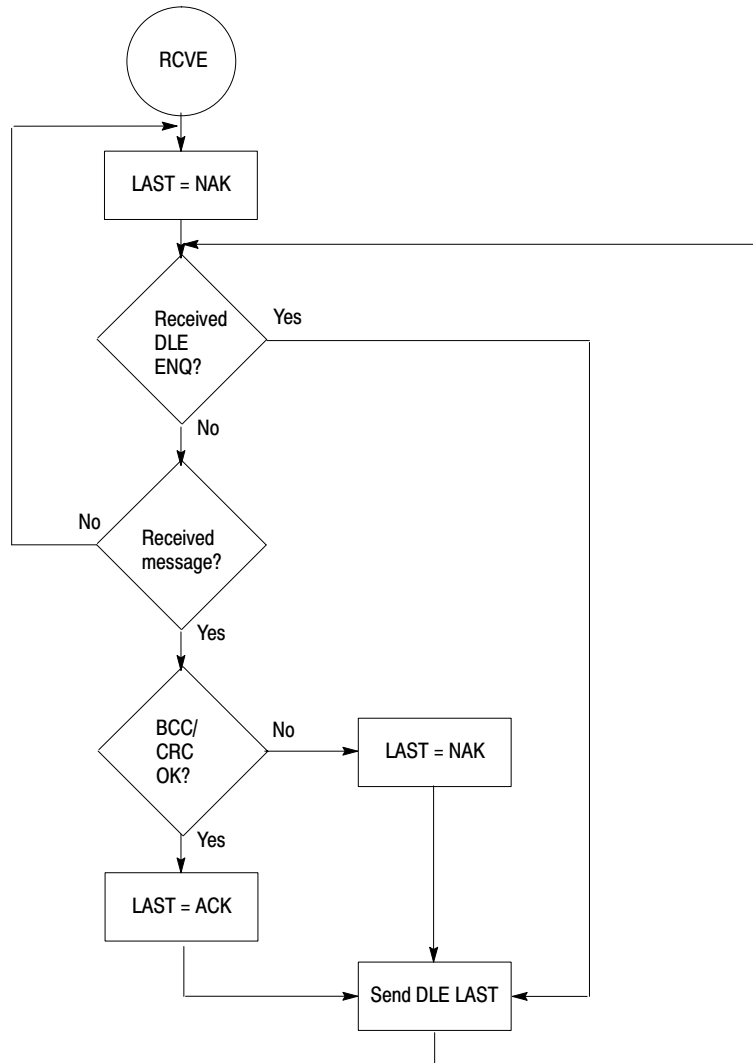

Full-duplex Protocol Diagrams

These transfer diagrams show events that occur on various interfaces. Time is represented as increasing from the top of the diagram to the bottom. Link-layer data bytes are represented by “xxxx” and corrupted data by “???”.

For this diagram	See page
normal message transfer	4-10
message transfer with NAK	4-11
message transfer with timeout & ENQ	4-12
message transfer with re-transmission	4-13
message transfer with message sink full	4-14
message transfer with NAK on reply	4-15
message transfer with timeout and ENQ for the reply	4-16
message transfer with message source full on the reply	4-17

Normal Message Transfer

In this transfer:

- the transmitter sends the data to the receiver
- the sink sends a “not full” message
- the receiver sends the data to the sink and sends a DLE ACK to the transmitter
- the transmitter tells the source that the data was delivered
- reply is successfully returned

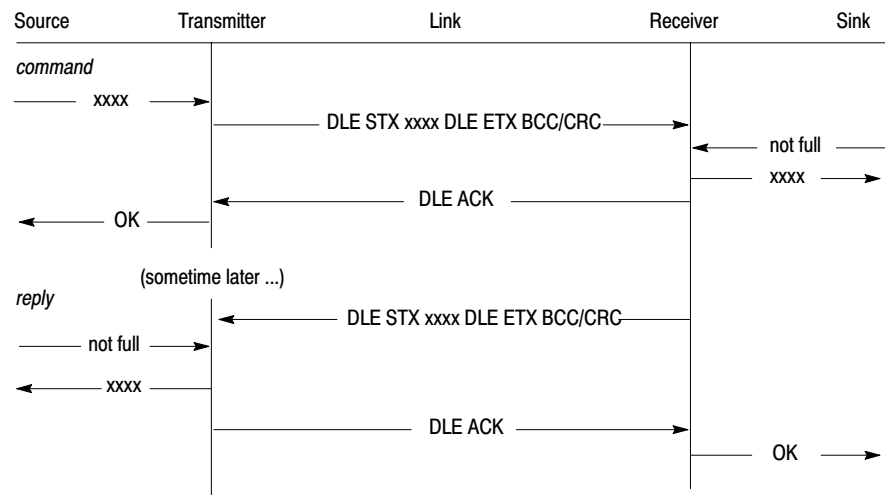

Message Transfer with NAK

In this transfer:

- the transmitter sends corrupted data to the receiver and the receiver responds with a DLE NAK
- the transmitter retransmits and the transmission is successful
- the receiver sends a DLE ACK to the transmitter
- reply is successfully returned

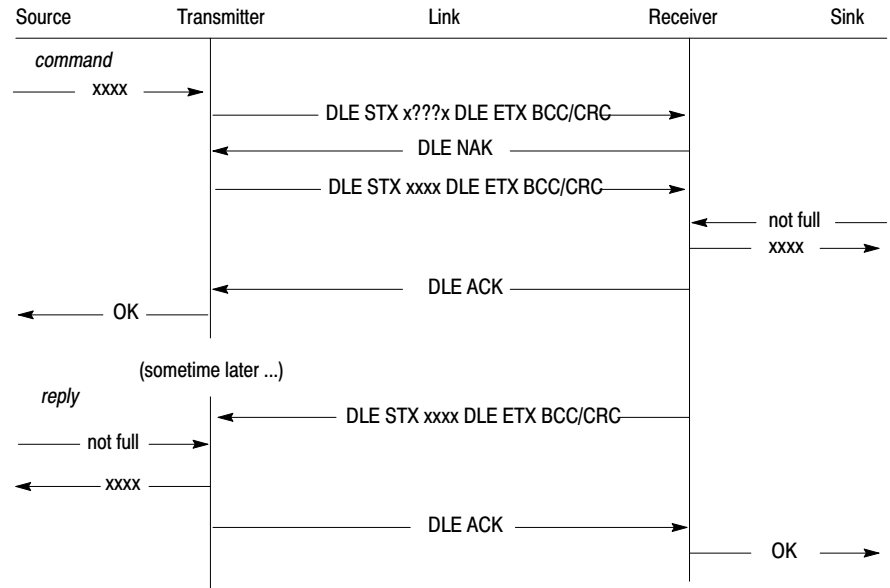

Message Transfer with Timeout and ENQ

In this transfer:

- the receiver receives a transmission, but sends back a DLE ACK that is corrupted
- the transmitter times out waiting for the DLE ACK and sends a DLE ENQ
- the receiver sends back a DLE ACK
- a reply is successfully returned

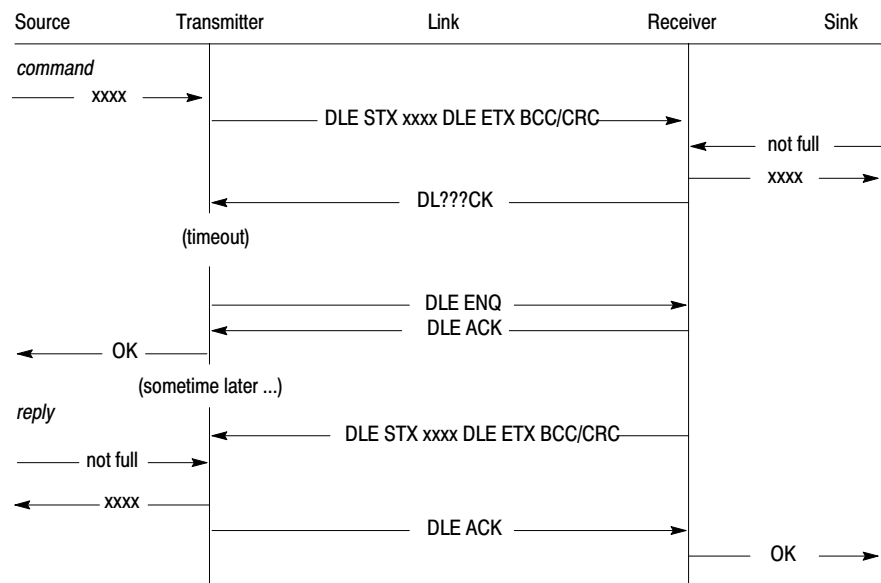

Message Transfer with Re-Transmission

In this transfer:

- noise destroys the DLE ACK while also producing invalid characters at the receiver
- because of the invalid characters, the receiver changes its last response variable to a DLE NAK
- since the DLE ACK was destroyed, the transmitter sends a DLE ENQ (enquiry), and the receiver returns the DLE NAK
- the transmitter retransmits the message and the receiver sends an ACK
- the receiver discards the duplicate message (if duplicate message detection is enabled on your module)
- reply is successfully returned

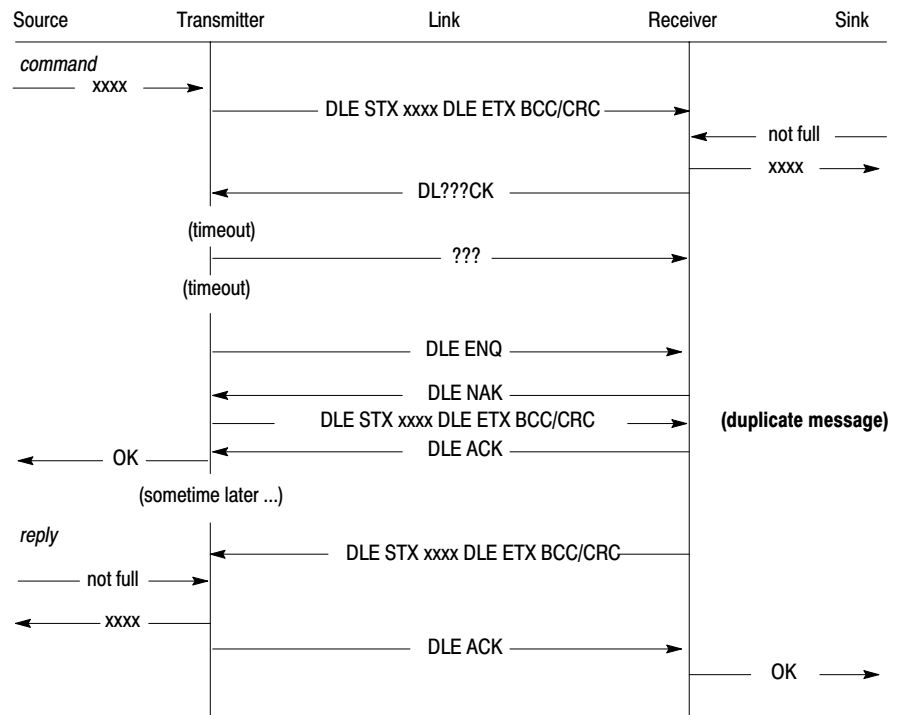

In this transfer, the receiver has no way of knowing that the DLE ACK it sent to the transmitter was destroyed. If the transmitter's ACK timeout is large enough, it is possible that the reply (i.e., DLE STX xxxx DLE ETX BCC/CRC) comes back before the transmitter sends the DLE ENQ. Therefore, the reply comes in before the DLE ACK is received by the transmitter.

Message Transfer with Message Sink Full

In this transfer:

- the transmitter sends a message but the message sink is full, so the receiver sends back a DLE NAK
- the transmitter retransmits and the sink is no longer full, so the receiver returns a DLE ACK
- a reply is successfully returned

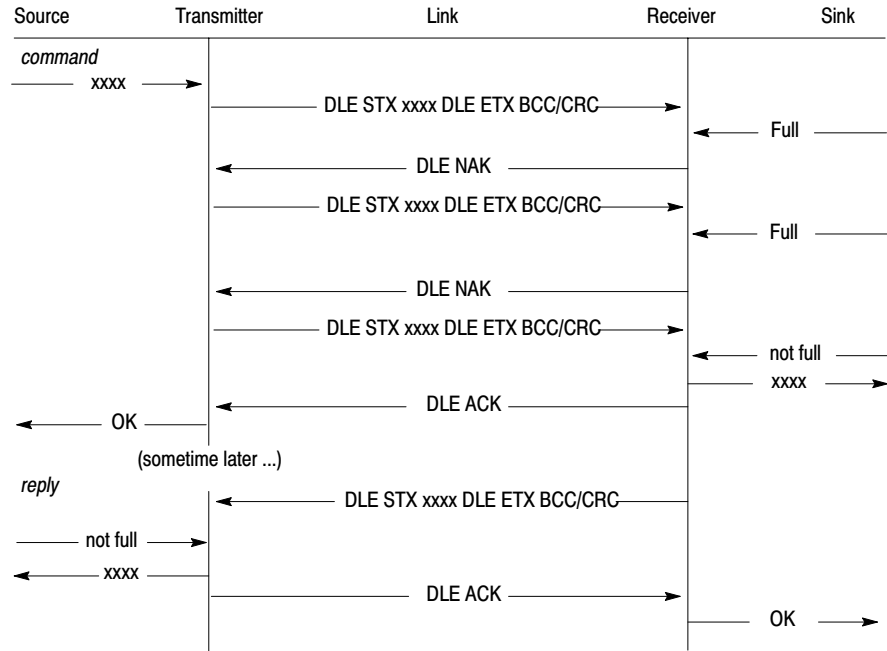

Message Transfer with NAK on Reply

In this transfer:

- the message is successfully transmitted on the network
- the reply is corrupted and the transmitter responds with a DLE NAK
- the reply is sent again and is successful

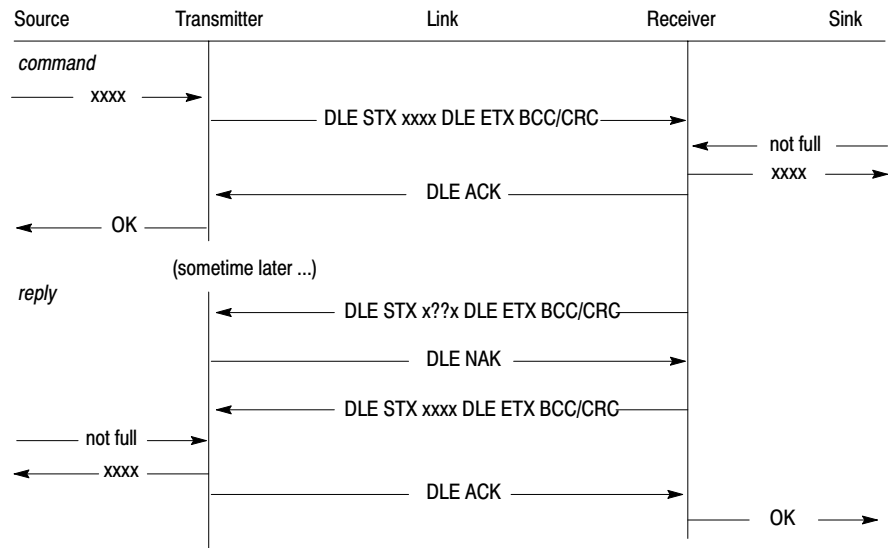

Message Transfer with Timeout and ENQ for the Reply

In this transfer:

- the message is successfully transmitted on the network
- the receiver sends a reply from the network but the transmitter sends back a DLE ACK that is corrupted
- the receiver times out waiting for the DLE ACK and sends a DLE ENQ
- the transmitter sends back a DLE ACK

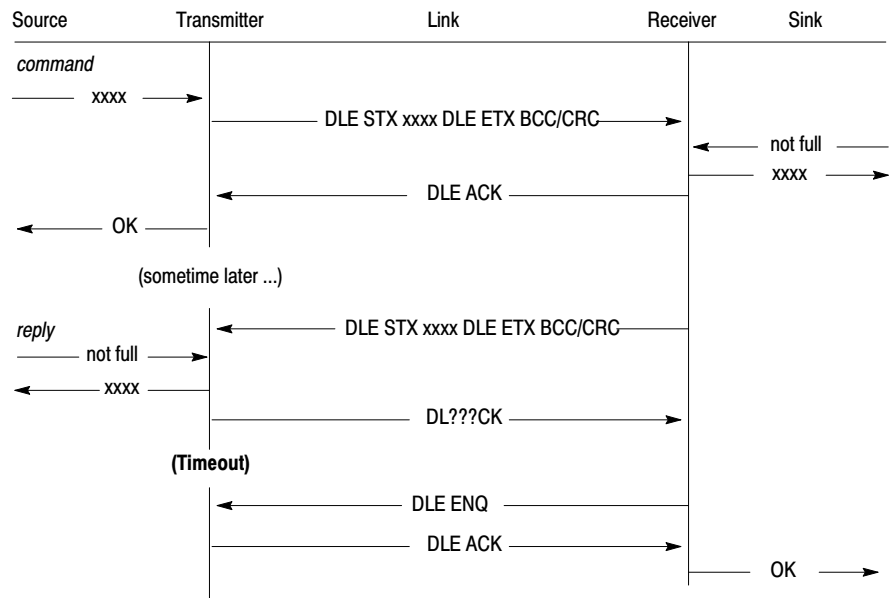

Message Transfer with Message Source Full on the Reply

In this transfer:

- the message is successfully transmitted on the network
- the receiver sends a reply but the message source is full, so the transmitter sends back a DLE NAK
- the receiver retransmits and the source is no longer full, so the transmitter returns a DLE ACK

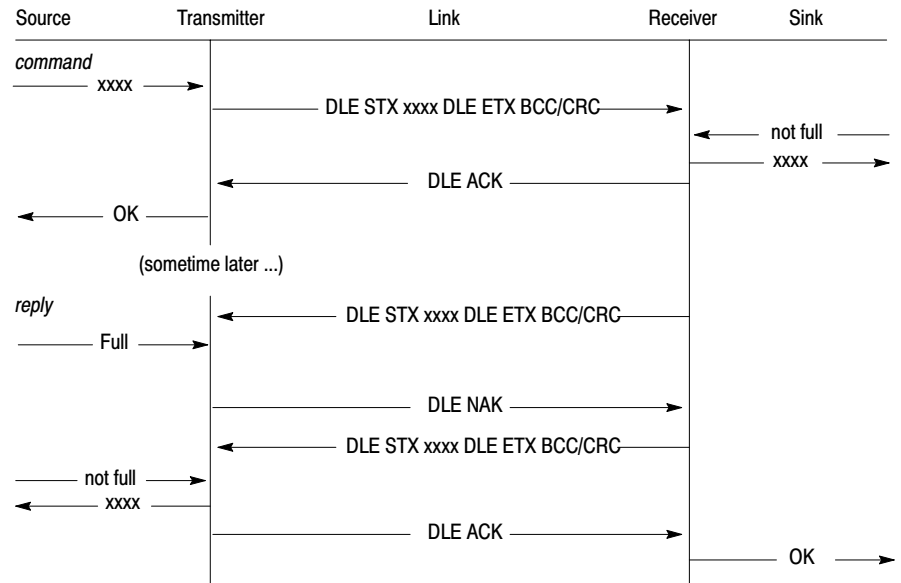

■ Message Packets ■

Data-link Layer Message Frames — Chapter 5

Application Layer Message Packets — Chapter 6

Communication Commands — Chapter 7

**Message Packet Status Codes (STS and EXT STS)
— Chapter 8**

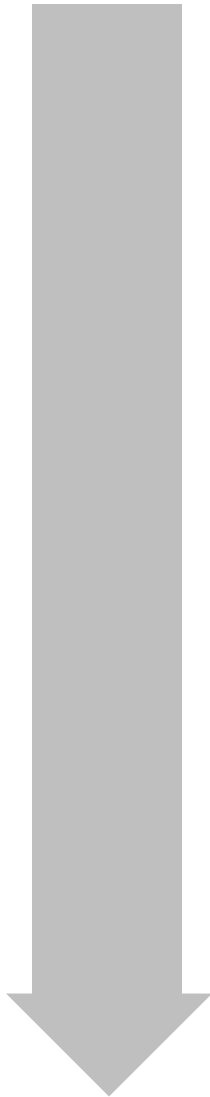

Data-link Layer Message Frames

In the data-link layer of a message frame:

- half-duplex protocol uses three types of message transmission
- full-duplex protocol implements its message fields at different network layers
- at the end of each polling and message frame, there is a one-byte BCC field or a two-byte CRC field

Read this chapter to help learn the fields that your computer uses in the data-link layer of a message frame. It contains these sections:

Section	Page
Half-duplex Protocol Message Frames	5-2
Full-duplex Protocol Message Frames	5-3
BCC and CRC Fields	5-4

Half-duplex Protocol Message Frames

Half-duplex protocol uses three types of transmissions:

- polling frame
- master message frame
- slave message frame

The master node transmits both polling frames and master message frames, and slave nodes transmit slave message frames.

The following figure illustrates the formats of these frames.

The slave message frame has the same format as the full-duplex message frame. The master message frame is the same as the slave message frame except that it is prefixed with DLE SOH and an address to specify a slave station address (STN).

Important: Even if you set your module to use CRC, when you send a polling frame, it uses a single BCC byte.

Polling Frame

DLE	ENQ	STN	BCC
-----	-----	-----	-----

Master Message Frame

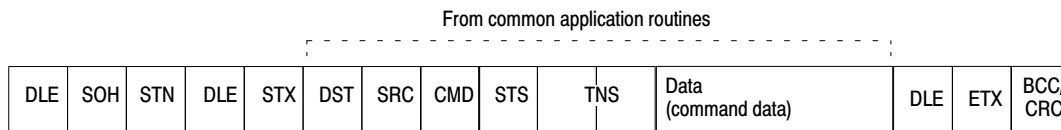

Slave Message Frame

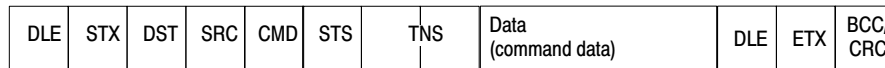

From common application routines

The BCC field contains the 2's complement of the 8-bit sum (module-256 arithmetic sum) of the slave station address (STN) and all the data bytes in the frame. For polling frames, the BCC is simply the 2's complement of STN. The BCC does not include any other message frame symbols or response symbols.

Full-duplex Protocol Message Frames

Full-duplex protocol implements different message frames, depending on the network layer. This figure shows the format of a message frame for full-duplex protocol and the layer at which each portion is implemented:

From user application program

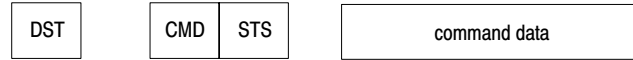

From common application routines

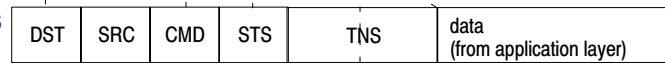

Data-link layer frame



The BCC/CRC field contains the 2's complement of the 8-bit sum (module-256 arithmetic sum) of all application layer data bytes between the DLE STX and the DLE ETX BCC. It does not include any response symbols. You can use the BCC/CRC field for one of the following types of error checking:

- block check character (BCC)
- 16-bit cyclic redundancy check (CRC-16)

BCC and CRC Fields

At the end of each polling frame and each message frame, there is a one-byte BCC (block check character) field, or a two byte CRC (cyclic redundancy check) field. You select BCC or CRC through switch settings or software configuration. Either field allows you to verify the accuracy of each message frame transmission:

- The BCC algorithm provides a medium level of data security:
 - it cannot detect transposition of bytes during transmission of a frame
 - it cannot detect the insertion or deletion of the value zero within a frame
- The CRC field provides a higher level of data security than BCC but is more difficult to implement

BCC Field

We've included both half- and full-duplex BCC examples:

Half-duplex protocol example

If the master node wants to send the hexadecimal data symbols 08, 09, 06, 00, 10, 04, and 03 to slave node 20₁₆ (40 octal), the master message symbols are:

```
10 01 20 10 02 08 09 06 00 10 10 04 03 10 03 B2
      STN DLE STX APP DATA (DLE DLE) DLE ETX BCC
```

The sum of the STN and application layer data bytes in this message frame is 4E₁₆. The BCC is the 2's complement of this sum, or B2₁₆. This is shown in the following binary calculation:

```
0100 1110 = sum (4E16)
1011 0001 = 1's complement
      +1
-----
1011 0010 2's complement (B216 = BCC)
```

To transmit the STN or data value 10 hex, you must use the data symbol DLE DLE. You must also use the data symbol DLE DLE if your STN value is 10. Only one of these DLE bytes, however, is included in the BCC sum.

For example, to transmit the data values 08, 09, 06, 00, 10, 04, and 03 (hex), a slave node uses the following message symbols:

```
10 02 08 09 06 00 10 10 04 03 10 03 D2
DLE STX APP DATA (DLE DLE) DLE EXT BCC
```

In this case, the sum of the data bytes is 2E hex because only one DLE byte is included in the BCC. The BCC (2's complement) of 2E₁₆ is D2₁₆.

Full-duplex protocol example

If a message frame contained the data 08, 09, 06, 00, 02, 04, and 03 (decimal), the message symbols are:

```

10    02    08 09 06 00 02 04 03    10    03    E0
DLE  STX          APP DATA      DLE  ETX  BCC

```

The sum of the application data bytes in this message frame is 32 decimal or 20 hex. The BCC is the 2's complement of this sum, or E0 hex. This is shown in the following binary calculation:

```

0010 0000  2016
1101 1111  1's compliment
   +1
-----
1110 0000  2's compliment (E0 hex)

```

To quickly determine a BCC value, add up the hex values of the application layer bytes. If the total is greater than 100 hex, drop the most significant digit. Then, subtract the result from 100 hex. This gives you the BCC. For example, if the sum of the application layer bytes is 20 hex, then:

```

10016
-2016
-----
E016

```

Important: To transmit the value 10 hex, you must use the data symbol DLE DLE. However, only **one** of these DLE data bytes is included in the BCC sum. For example, to transmit the values 08, 09, 06, 00, 10, 04, and 03 hex, use the following message symbols:

```

10    02    08 09 06 00 10 10 04 03    10    03    D2
DLE  STX          APP DATA (DLE DLE)  DLE  EXT  BCC

```

In this case, the sum of the application layer data bytes is 2E hex because only one DLE byte is included in the BCC. So the BCC is D2₁₆. This is sometimes referred to as "double-stuffing" DLEs.

Important: If your BBC check sum is 10 hex, send it as "10" and not "10 10." That is, a BCC is not treated like data.

CRC Field

For these protocols	You calculate the CRC value ^①
full-duplex	using the value of the link-layer data bytes and the ETX byte.
half-duplex	<ul style="list-style-type: none"> • for master messages using the value of the link-layer data bytes and the STN, STX and ETX bytes^② • for slave messages using the value of the link-layer data bytes and the ETX byte

^① The polynomial for a CRC value is: $X^{16} + X^{15} + X^2 + X^0$.

^② Do not add in the associated DLE for STX and ETX values.

Important: To transmit the data value of 10_{16} , you must use the data symbol DLE DLE. However, only one of these DLE bytes is included in the CRC value. Embedded responses are not included in the CRC value.

The following explains the transmission of the CRC value:

1. At the start of a message frame, the transmitter clears a 16-bit register used for the CRC value.
2. As a byte is transmitted, it is exclusive-ORed (least-significant bit to the right) with the right eight bits of the CRC register.
3. The result is placed in the right eight bits of the CRC register.
4. The CRC register is then shifted right eight times by inserting 0s on the left. Each time a 1 is shifted out on the right, the CRC register is exclusive-ORed with this 16-bit constant:
1010 0000 0000 0001
5. As each additional byte is transmitted, it is included in the value in the register the same way.
6. After the ETX value is transmitted, the value in the CRC register is transmitted (right bit first). The receiver also calculates the CRC value and compares it to the received CRC value to verify the accuracy of the data received.

The full-duplex and half-duplex slave and master protocol examples below provide you with procedures for determining the CRC-16 value.

Full-duplex and half-duplex slave protocol

```

data_byte = all link-layer data, ETX
CLEAR CRC_REGISTER
FOR each data_byte
  GET data_byte
  XOR (data_byte, right eight bits of CRC_REGISTER)
  PLACE RESULT in right eight bits of CRC_REGISTER

  DO 8 times (on CRC register_
    Shift bit right, shift in 0 at left
    IF bit shifted = 1
      XOR (CONSTANT, CRC_REGISTER)
      PLACE RESULT in CRC_REGISTER
    END IF
  END DO
END FOR
TRANSMIT CRC_REGISTER as 2-byte CRC field (low byte, high byte)

```

Half-duplex master protocol

```

data_byte = STN, STX, all link-layer data, ETX
CLEAR CRC_REGISTER
For each data_byte
  GET data_byte
  XOR (data_byte, right 8 bits of CRC_REGISTER)
  PLACE RESULT in right 8 bits of CRC_REGISTER
  DO 8 times
    Shift bit right, shift in 0 at left
    IF bit shifted = 1
      XOR (CONSTANT, CRC_REGISTER)
      PLACE RESULT in CRC_REGISTER
    END IF
  END DO
END FOR
TRANSMIT CRC_REGISTER as 2 byte CRC field

```

Below is an actual frame that you can use to validate your CRC routine:

Use this frame to validate the CRC

10 | 02 | 07 | 11 | 41 | 00 | 53 | B9 | 00 00 00 00 00 00 00 00 00 00 00 00 | 10 | 03 | 6B 4C

Application Layer Message Packets

Read this chapter to help learn about the application layer for your asynchronous driver and the fields that your computer uses in the application layer of a message packet. It contains these sections:

Section	Page
How Your Application Program Sends and Receives Messages	6-2
Message Packet Format	6-3

How Your Application Program Sends and Receives Messages

There are two types of application programs:

- command **initiators**
- command **executors**

This application program	Sends
command initiator	<p>command messages – specify which command function to execute at a particular remote node</p> <p>Each command message requires one reply message. The command initiator must check for error codes and, depending on the type of error, retransmit the message or notify the user.</p> <p>The command initiator should also use a timer to be aware of lost reply messages (due to noise or other factors). If the time limit expires before the initiator receives the reply, the initiator can retransmit or notify the user.</p>
command executor	<p>reply messages – responsible for interpreting and executing the command message.</p> <p>The executor must issue a reply message for each command it receives. If the executor cannot execute a command, it must send the appropriate error code.</p>

Internally, Allen-Bradley asynchronous interface modules use a routing subroutine and a message queue. When the module receives a message over its asynchronous link, it puts the message in its queue. The routing subroutine then takes the message from the queue and transmits it over the DH, DH+, or DH485 network. The module also queues messages received from the network. The routing subroutine takes these messages and retransmits them over the asynchronous link.

If this layer	Cannot deliver a	It should
application	command message	generate a reply message with the appropriate error code and send the reply to the initiator.
	reply message	destroy the reply without notification to the command executor.
data-link	message over the asynchronous link	return an error message to the command initiator.

Message Packet Format

Most devices send and receive messages using this message packet format:

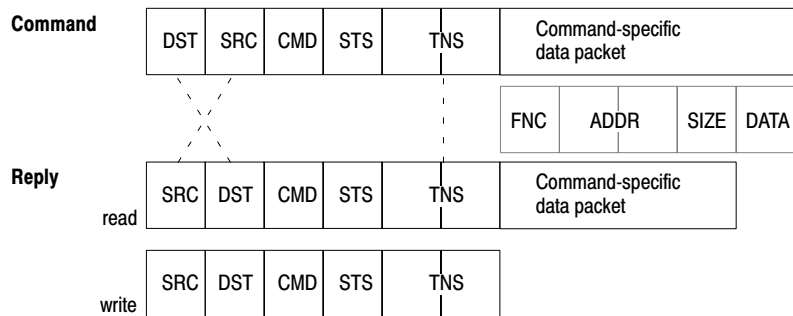

The bytes are shown from left to right in the order they are transmitted across the link.

Field	Contents	See
DST	destination node for the message	page 6-4
SRC	source node of the message	
FNC	function code	page 6-5
CMD	command code	
ADDR	address of memory location (2 bytes)	page 6-8
STS	status code	page 6-6
EXT STS	extended status code	
SIZE	number of bytes to be transferred	page 6-8
TNS	transaction number (2 bytes)	page 6-7
DATA	data values being transferred by the message The number of data bytes in a message depends on the command or function being executed.	Chapter 7

The combination of SRC, CMD, and TNS bytes uniquely identifies every message packet. One of these fields in the current message must be different than the corresponding field in the last message received by a command executor. If all fields are the same, the message is ignored and is considered to be a duplicate. If the receiving module has the “ignore duplicate messages” option enabled, the message will be ignored.

DST and SRC

Form the DST and SRC bytes of a reply message by interchanging the DST and SRC bytes of the corresponding command message:

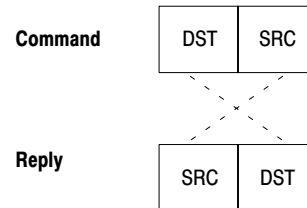

Byte	Contents	Value supplied by	Value range
DST (destination)	receiving message	application layer	<ul style="list-style-type: none"> • 0 to 376 (octal) for DF1 • 0 to 376 (octal) for DH
SRC (source)	sending message	data link layer	<ul style="list-style-type: none"> • 0 to 77 (octal) for DH+ • 0 to 31 (decimal) for DH485

When sending messages from asynchronous devices, special consideration must be given to the SRC byte:

When sending a message from an asynchronous device connected	Set the SRC byte
to the network ^①	= 0 (the module will set the byte to its own node number)
directly to a 1771-KG	≤ 10 (octal)

^① If you connect to channel 0 of a PLC-5/11, -5/20, -5/30, -5/40, -5/60 or -5/80 processor and you send a PLC-2 *unprotected write*, *protected write*, *protected bit write*, or *unprotected bit write*, what you put into the SRC byte is very important. This determines the compatibility file. This means that the value of the SRC byte specifies the data table file number that is written to the PLC-5 processor. The source byte will not be overwritten by channel 0. For SLC 500 processors, the compatibility file is always 9.

CMD and FNC

These bytes work together to define the activity that is to be performed by the command message at the destination node. Values for these bytes are supplied by the application layer. The message format depends on the CMD and FNC values.

CMD byte

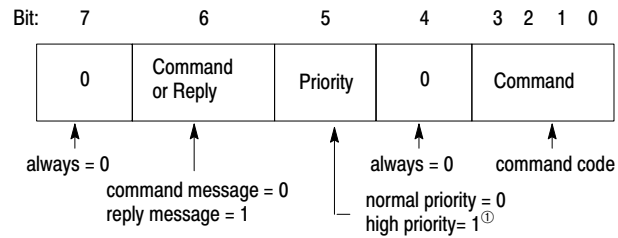

① High priority only applies to DH links. It does not apply to DH+, DH485, or DHII links.

This byte	Defines the	And has these values
CMD (command)	command type	see table that begins on page 7-2
FNC (function)	specific function under that command type	

Example code

PLC-2 command — *enter download mode*

send = **00000111** (07 hex)
 reply = **01000111** (47 hex)
 high-priority send (DH only) = **00100111** 27 hex
 high-priority reply (DH only) = **01100111** (67 hex)

STS and EXT STS

These bytes work together to indicate the status of the message transmission.

This byte	In this message	Has this value
STS (status)	command	The application program sets = 0.
	reply	= 0 when the command has executed with no error.
EXT STS ^① (extended status)	reply	= one of the status codes listed in Chapter 8, "Message Packet Status Codes (STS, EXT STS)." This byte will also \neq 0 if an error occurs.

^① EXT STS is part of the message only if STS = F0.

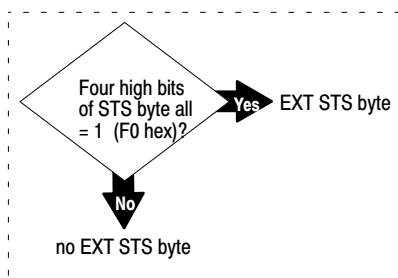

STS byte

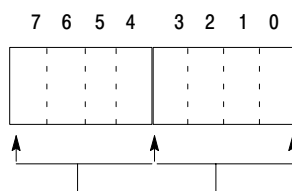

Application layer uses these bits (and in some cases the EXT STS byte), to report remote errors — errors that occur when the command executor at the destination node tries to execute the command message).

Link layer uses these bits to report local errors — errors that occur when the link layer attempts to transmit a message across the link.



STS and EXT STS error codes

For more information on STS and EXT STS error codes, see Chapter 8, "Message Packet Status Codes (STS, EXT STS)."

TNS

The TNS (transaction) bytes contain a unique 16-bit transaction identifier. Generate this number by maintaining a 16-bit counter. Increment the counter each time your command initiator (application program) creates a new message, and store the counter value in the two TNS bytes of the new message. In a multi-tasking environment, you must use only one TNS counter, and the procedure to read and increment the TNS must be indivisible.

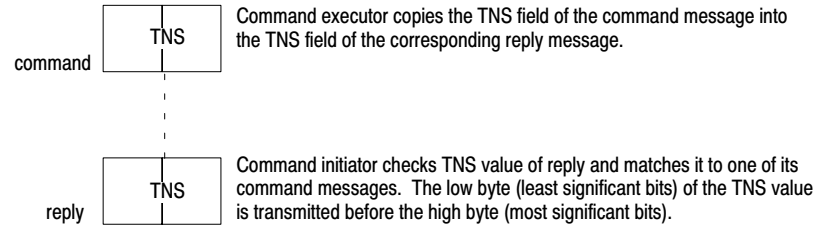

For command messages transmitted by	Values are assigned by
a PLC	the interface module assigns the TNS values.
computer node	your application level software. The software must assign a unique 16-bit transaction number.

Important: Do not change the TNS value in a reply message. If you change this value, the command initiator cannot match its command to the corresponding reply message.

ADDR

The ADDR (address) bytes contain the byte address of a memory location in the command executor where the command is to begin executing, except in SLC 500 processors, where the ADDR byte is interpreted as the word address.

In SLC 5/02, SLC 5/03, and SLC 5/04 processors, the CIF Addressing Mode bit, S:2/8, can be set to a one to change the interpretation of the ADDR byte to the byte address, so that it is compatible with other PLC processors. For example, if the command is to read data from the command executor, ADDR specifies the address of the first byte of data to be read.

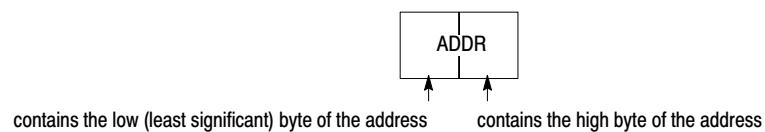

▶ Sending commands to PLC-3, PLC-5, and SLC 500 processors

In some instances, when sending commands from the basic command set to a PLC-3, PLC-5, or PLC-5/250 processor, or to an SLC 500 processor, you must create special files to accept the data.

Important: The ADDR field specifies a byte address, not a word address as in PLC data tables. Chapter 13, “PLC Addressing,” explains how to convert PLC word addresses to byte addresses. Also, if you use the “native” read and write commands in PLC-3, PLC-5, or SLC 500 processors, the address is not a byte address; it is a logical binary, logical ASCII, or SLC address with multiple address fields.

SIZE

The SIZE byte specifies the number of data bytes to be transferred by a message. This field appears in read commands, where it specifies the number of data bytes that the responding node must return in its reply message.

The SIZE varies with the type of command. For PLC-5 and PLC-5/250 *typed read* and *typed write* commands, the SIZE field specifies the number of elements, not bytes. In PLC-5 *typed read* and *typed write* commands, the SIZE field is two bytes long—transmit low byte first and high byte second.

Communication Commands

This chapter contains the format you should use when sending communication commands to Allen-Bradley processors. Use this key to help learn the conventions that depict the communication commands listed in this chapter:

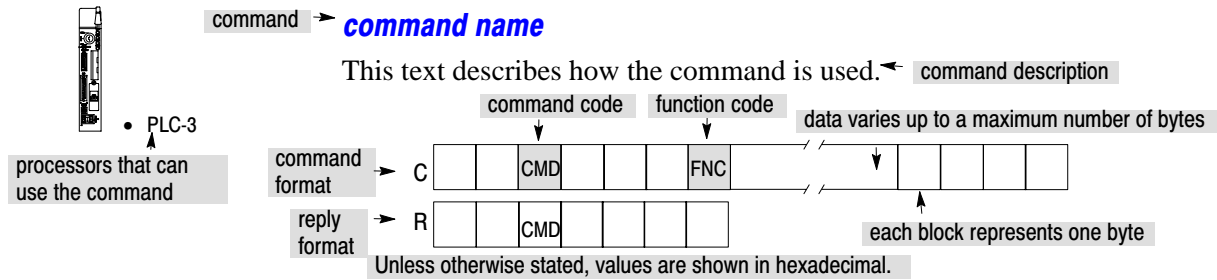

Message packets

The message packets for these commands include STS and possibly EXT STS fields that contain status and error code information. For more information on these bytes, see Chapter 8, “Message Packet Status Codes (STS, EXT STS).”

Protecting data files from write access

Using a PLC-5/11, -5/20, 5/30, -5/40, -5/60, or -5/80 processor, you can also specify privileges to protect data files from write access on a DH+ link. Using an SLC 5/02, 5/03, or 5/04 processor, you can specify static file protection to protect data files from write access from any of the communication channels.

Important: In some cases, switch settings on an interface module can disable a command at a PLC/SLC node. For additional information on your module’s switch settings, refer to that module’s user documentation. (For a list of related publications and products, refer to the preface of this manual.)

In addition to the commands listed in this chapter, we’ve also included examples:

Section	Page
PLC-5 Type/Data Parameter Examples	7-36
SLC 500 Information	7-38
Reading and Writing SLC 500 Data (using SLC terminology)	7-38
Reading and Writing SLC 500 Data (using PLC-2 terminology)	7-38

Use this table to locate commands you want to use. For additional information on the commands, refer to the specified pages.



ATTENTION: Using command codes not listed will produce unpredictable results.

Command	CMD	FNC	Processors										Page	
			Micro-Logix 1000	SLC 500	SLC 5/03	SLC 5/04	1774-PLC	PLC-2	PLC-3	PLC-5	PLC-5 /250	PLC-5/ VME		
<i>apply port configuration</i>	0F	8F			✓	✓							✓	7-4
<i>bit write</i>	0F	02									✓ ^⑤	✓		7-4
<i>change mode</i>	0F	3A	✓	✓										7-5
	0F	80			✓	✓								7-5
<i>close file</i>	0F	82	✓	✓	✓	✓								7-5
<i>diagnostic status</i>	06	03	✓	✓	✓	✓	✓	✓	✓	✓	✓ ^⑤	✓ ^⑤		7-6
<i>disable forces</i>	0F	41	✓	✓	✓	✓					✓ ^⑤	✓ ^⑤		7-6
<i>disable outputs</i>	07	00					✓							7-6
<i>download all request</i>	0F	50									✓	✓ ^⑤	✓	7-7
<i>download completed</i>	0F	52	✓	✓	✓	✓					✓	✓ ^⑤	✓	7-7
<i>download request</i>	0F	05							✓					7-8
<i>echo</i>	06	00	✓	✓	✓	✓	✓	✓	✓	✓	✓ ^⑤			7-8
<i>enable outputs</i>	07	01					✓							7-9
<i>enable PLC scanning</i>	07	03					✓							7-9
<i>enter download mode</i>	07	04						✓						7-9
<i>enter upload mode</i>	07	06						✓						7-10
<i>exit download/upload mode</i>	07	05						✓						7-10
<i>file read</i>	0F	04							✓			✓		7-10
<i>file write</i>	0F	03							✓			✓		7-11
<i>get edit resource</i>	0F	11		✓	✓	✓					✓	✓ ^⑤	✓	7-11
<i>initialize memory</i>	0F	57	✓	✓	✓	✓					✓ ^⑤	✓ ^⑥		7-12
<i>modify PLC-2 compatibility file</i>	0F	5E									✓			7-12
<i>open file</i>	0F	81	✓	✓	✓	✓								7-13
<i>physical read</i>	04	③					✓	✓						7-13
	0F	09							✓					7-13
<i>physical write</i>	0F	08							✓					7-14
<i>protected bit write</i>	02	③					✓	✓	✓	✓	✓			7-15
<i>protected typed file read</i>	0F	A7	✓	✓	✓	✓								7-16

① This command cannot be executed by channel 0 of a PLC-5/11, -5/20, -5/30, -5/40, -5/60, or -5/80 processor.

② The following processors can initiate these commands but cannot respond to them:

Processor Series/Revision Processors:

Series A / revision M PLC-5/40, -5/40L, -5/60, -5/60L

Series A / revision J PLC-5/30

Series A / revision H PLC-5/11, -5/20

Series B / revision J PLC-5/40, -5/40L, -5/60, -5/60L

Series C / revision G PLC-5/11, -5/20, -5/20E, -5/30, -5/40, -5/40L, -5/V40, -5/V40L, -5/60, -5/60L, -5/80, -5/80E, -5/V80

③ This command has no FNC byte.

④ SLC 500 refers to any SLC 500, SLC 5/01, SLC 5/02, SLC 5/03, or SLC 5/04 processor.

⑤ Receive only. Processors with this note cannot send the command; they receive the command from a computer.

Command	CMD	FNC	Processors										Page	
			Micro-Logix 1000	SLC 500 ^④	SLC 5/03	SLC 5/04	1774-PLC	PLC-2	PLC-3	PLC-5	PLC-5 /250	PLC-5/VME		
<i>protected typed file write</i>	0F	AF	✓	✓	✓	✓								7-16
<i>protected typed logical read with three address fields</i>	0F	A2	✓	✓	✓	✓				✓				7-17
<i>protected typed logical write with three address fields</i>	0F	AA	✓	✓	✓	✓				✓ ^②				7-18
<i>protected write</i>	00	③					✓	✓	✓	✓				7-19
<i>read bytes physical</i>	0F	17								✓	✓ ^⑤	✓		7-19
<i>read diagnostic counters</i>	06	01	✓	✓	✓	✓	✓	✓	✓	✓	✓ ^⑤			7-19
<i>reset diagnostic counters</i>	06	07	✓	✓	✓	✓	✓	✓	✓	✓	✓ ^⑤			7-22
<i>read link parameters</i>	06	09	✓	✓	✓	✓								7-20
<i>read-modify-write</i>	0F	26								✓	✓ ^⑤	✓		7-20
<i>read-modify-write N</i>	0F	79									✓ ^⑤			7-21
<i>read section size</i>	0F	29							✓	✓	✓ ^⑤			7-22
<i>restart request</i>	0F	0A							✓					7-23
<i>return edit resource</i>	0F	12											✓	7-24
<i>set CPU mode</i>	0F	3A	✓							✓	✓ ^⑤			7-26
<i>set data table size</i>	06	08						✓						7-24
<i>set ENQs</i>	06	06						✓	✓	✓ ^①	✓ ^⑤			7-25
<i>set link parameters</i>	06	0A	✓	✓	✓	✓								7-25
<i>set NAKs</i>	06	05						✓	✓	✓ ^①	✓ ^⑤			7-25
<i>set timeout</i>	06	04						✓	✓	✓ ^①	✓ ^⑤			7-27
<i>set variables</i>	06	02						✓	✓	✓ ^①	✓ ^⑤			7-27
<i>shutdown</i>	0F	07							✓					7-28
<i>typed read</i>	0F	68			✓	✓				✓	✓	✓		7-28
<i>typed write</i>	0F	67			✓	✓				✓	✓	✓		7-30
<i>unprotected bit write</i>	05	③					✓	✓	✓	✓	✓			7-30
<i>unprotected read</i>	01	③	✓	✓	✓	✓	✓	✓	✓	✓	✓			7-31
<i>unprotected write</i>	08	③	✓	✓	✓	✓	✓	✓	✓	✓	✓			7-32
<i>upload all request (upload)</i>	0F	53								✓	✓ ^⑤	✓		7-33
<i>upload completed</i>	0F	55								✓	✓ ^⑤	✓		7-34
<i>upload</i>	0F	06							✓					7-34
<i>word range read</i>	0F	01							✓	✓	✓			7-34
<i>word range write</i>	0F	00							✓	✓	✓			7-35
<i>write bytes physical</i>	0F	18								✓	✓ ^⑤	✓		7-35

① This command cannot be executed by channel 0 of a PLC-5/11, -5/20, -5/30, -5/40, -5/60, or -5/80 processor.

② The following processors can initiate these commands but cannot respond to them:

Processor Series/Revision Processors:

- Series A / revision M PLC-5/40, -5/40L, -5/60, -5/60L
- Series A / revision J PLC-5/30
- Series A / revision H PLC-5/11, -5/20
- Series B / revision J PLC-5/40, -5/40L, -5/60, -5/60L
- Series C / revision G PLC-5/11, -5/20, -5/20E, -5/30, -5/40, -5/40L, -5/V40, -5V40L, -5/60, -5/60L, -5/80, -5/80E, -5/V80

③ This command has no FNC byte.

④ SLC 500 refers to any SLC 500, SLC 5/01, SLC 5/02, SLC 5/03, or SLC 5/04 processor.

⑤ Receive only. Processors with this note cannot send the command; they receive the command from a computer.

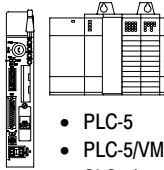
apply port configuration

- PLC-5
- PLC-5/VME
- SLC 5/03
- SLC 5/04

Changes the configuration of some or all ports. If there are no parameters, changes all ports. This command reconfigures the ports based on information in the processor's physical memory. It is normally used as part of a physical download operation where the processor memory and configuration are to be fully restored. A programming device must have the edit resource to use this command.

C	DST	PSN	SRC	PSN	CMD 0F	STS	TNS	FNC 8F	A	B	
R	LNH HI	LNH LO	DST	PSN	SRC	PSN	CMD 4FH	STS	TNS	EXT STS	Data

A - number of ports to change is a one-byte field—00 means "all ports."

B - port numbers in this list are two bytes each, low byte first.

Data - returned only if there is an EXT STS error 12H. It contains the file and element that relate to the error.

LNH - length of the optional portion of the reply packet in bytes.

**First four words of *apply port configuration***

The first four words are currently unused and unexamined. To assure compatibility with any future use of these bytes, they should be initialized to 0. DST, PSN, and SRC are included for reference only.

bit write (write bit)

- PLC-3
- PLC-5
(receive only)
- PLC-5/250

Modifies the bits at the address specified by either a word symbol, a file symbol plus a word offset, or a logical address. This address must point to a word within a file. The function code is 2. Unlike *unprotected writes* and *protected bit writes*, this command can change the bits in a single word only.

C	DST	SRC	CMD 0F	STS	TNS	FNC 02	PLC-3 Logical Address (2 - 51 bytes.)	Set Mask	Reset Mask
R	SRC	DST	CMD 4F	STS	TNS	EXT STS			

The EXT STS field may be attached to the reply packet only when there is an error.

change mode

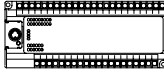

- MicroLogix 1000
- SLC 500
- SLC 5/03
- SLC 5/04

MicroLogix 1000

Changes the mode of the MicroLogix processor.

C	DST	SRC	CMD 0F	STS	TNS	FNC 3A	Mode xxh
R	SRC	DST	CMD 4F	STS	TNS	EXT STS	

Mode - 01 = change to Program mode (REM program)
02 = change to Run mode

The EXT STS field may be attached to the reply packet only when there is an error.

SLC 500

Changes the mode of the SLC processor. For an SLC 5/03 or SLC 5/04 processor, *change mode* only works when the keyswitch is in the REM position.

C	DST	SRC	CMD 0F	STS	TNS	FNC 80	Mode xxh
R	SRC	DST	CMD 4F	STS	TNS	EXT STS	

Mode - 01 = change to PROGRAM mode (REM program)
06 = change to RUN mode (REM Run)
07 = change to TEST-Cont. Scan Mode (REM Test)
08 = change to TEST-Single Scan Mode (REM Test)
09 = change to TEST-Debug Single Step (REM Test).
SLC 500 and SLC 5/01 processors do not support 09 mode

The EXT STS field may be attached to the reply packet only when there is an error.

close file

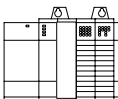

- SLC 500
- SLC 5/03
- SLC 5/04

Closes a file in an SLC 500 processor. When closing program file 0 (in an SLC 500, SLC 5/01, or SLC 5/02 processor) after it has been opened for write, the SLC processor calculates the LRC for the directory, data and internal files.

C	DST	SRC	CMD 0F	STS	TNS	FNC 82	Tag
R	SRC	DST	CMD 4F	STS	EXT STS		

The EXT STS field may be attached to the reply packet if there is an error.

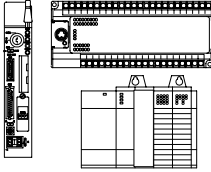
diagnostic status

- 1774-PLC
- MicroLogix 1000
- PLC-2
- PLC-3
- PLC-5
- PLC-5/250 (receive only)
- SLC 500
- SLC 5/03
- SLC 5/04

Reads a block of status information from an interface module. The reply contains the status information in its DATA field. The status information varies with the type of interface module. (For additional information, see Chapter 10, “Diagnostic Status Information.”)

C	DST	SRC	CMD 06	STS	TNS	FNC 03
R	SRC	DST	CMD 46	STS	TNS	Data (max. 244 bytes)

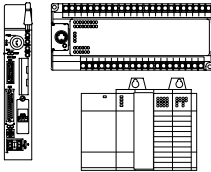
disable forces

- MicroLogix 1000
- PLC-5
- PLC-5/250 (receive only)
- SLC 500
- SLC 5/03
- SLC 5/04

Disables the forcing function for I/O. All forcing data is ignored, but remains intact.

C	DST	SRC	CMD 0F	STS	TNS	FNC 41
R	SRC	DST	CMD 4F	STS	TNS	EXT STS

disable outputs

- 1774-PLC

Turns off all of the 1774-PLC processor’s outputs. Use this command to disable the outputs before sending a *physical write*.

C	DST	SRC	CMD 07	STS	TNS	FNC 00
R	SRC	DST	CMD 47	STS	TNS	

download all request (download)



- PLC-5
- PLC-5/250 (receive only)
- PLC-5/VME

Places a PLC-5 processor in Download mode before downloading a complete system. A “no privilege” error is returned if the requestor does not have privilege to place the processor in Download mode.

This error occurs when:

- the processor is in Run or Remote Run mode (must be in Program or Remote Program mode)
- the processor is being edited
- some other node is already downloading to the processor

C	DST	SRC	CMD 0F	STS	TNS	FNC 50
R	SRC	DST	CMD 4F	STS	TNS	EXT STS

The EXT STS field may be attached to the reply packet only when there is an error.

download completed

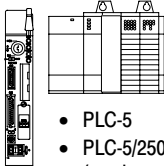

- PLC-5
- PLC-5/250 (receive only)
- PLC-5/VME
- SLC 500
- SLC 5/03
- SLC 5/04

Use after downloading a complete system to place the processor back in the mode that it was in. (For PLC-5 processors, it returns to the mode it was in prior to executing *download all request*.)

C	DST	SRC	CMD 0F	STS	TNS	FNC 52
R	SRC	DST	CMD 4F	STS	TNS	EXT STS

The EXT STS field may be attached to the reply packet only when there is an error.



- PLC-3

download request (download privilege)

Used by a computer to inform an interface module that it wants to perform a download. If the module grants the download privilege, the computer may begin issuing *physical reads* or *physical writes*. If another node already has the download privilege, the second node is denied the privilege.

Before performing an upload/download, issue *diagnostic status* to get the last word of memory to read or write. Bytes 11-14 in the *diagnostic status* reply return E60.0.0—this is the start of unused memory. Start your read or write at 00 00 00 00.

C	DST	SRC	CMD 0F	STS	TNS	FNC 05
R	SRC	DST	CMD 4F	STS	TNS	EXT STS

The EXT STS field may be attached to the reply packet only when there is an error.

echo

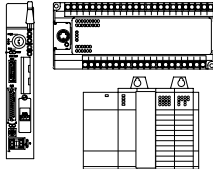

- 1774-PLC
- MicroLogix 1000
- PLC-2
- PLC-3
- PLC-5
- PLC-5/250
(receive only)
- SLC 500
- SLC 5/03
- SLC 5/04

Checks the integrity of transmissions over the communication link. The command message transmits up to 243 bytes of data to a node interface module. The receiving module should reply to this command by transmitting the same data back to the originating node.

C	DST	SRC	CMD 06	STS	TNS	FNC 00	Data (max. 243 bytes)
R	SRC	DST	CMD 46	STS	TNS	Data (max. 243 bytes)	

For SLC 500, SLC 5/01, and SLC 5/02 processors, maximum data size is 95 bytes; for SLC 5/03 and SLC 5/04 processors, maximum data size is 236 bytes.

enable outputs

- 1774-PLC

Returns control of the outputs to the 1774-PLC ladder diagram program. Use this command to cancel the effect of *disable outputs*.

C	DST	SRC	CMD 07	STS	TNS	FNC 01
R	SRC	DST	CMD 47	STS	TNS	

enable PLC scanning

- 1774-PLC

Restarts the 1774-PLC processor's program scanner after a *physical write* has been performed.

C	DST	SRC	CMD 07	STS	TNS	FNC 03
R	SRC	DST	CMD 47	STS	TNS	

enter download mode



- PLC-2

Puts the PLC-2 processor in the download mode. Use this command on a PLC-2 node before sending a *physical write* to the node.

C	DST	SRC	CMD 07	STS	TNS	FNC 04
R	SRC	DST	CMD 47	STS	TNS	

Important: For early revisions of the 1771-KA2 and the industrial terminal, when you send an *enter download/upload mode*, the industrial terminal port is disabled until you send an *exit download/upload mode*. When the industrial terminal port is disabled, the industrial terminal enters the mode select state. To leave this state, you must manually select a mode at the industrial terminal.

If you are using	Use
<ul style="list-style-type: none"> •1771-KA/A revision F •1771-KG/A 	<i>enter download mode</i> before sending physical read commands.
<ul style="list-style-type: none"> •1771-KA2/B •1771-KG/B or later 	<i>enter upload mode</i> before sending physical read commands.

enter upload mode

- PLC-2

Puts the PLC-2 processor in Upload mode. Use this command on a PLC-2 node before sending a *physical read* to the node.

C	DST	SRC	CMD 07	STS	TNS	FNC 06
R	SRC	DST	CMD 47	STS	TNS	

Important: When you send an *enter upload mode*, the industrial terminal port is disabled until you send an *exit download/upload mode*.

exit download/upload mode

- PLC-2

Takes the PLC-2 processor out of the Upload or Download mode. Use this command to restart the PLC-2 processor after performing an upload or download operation.

Important: Do not send this command after a download/upload command; you must recycle power to the 1771-KA, -KA2, -KG, or 1785-KA3 module to enable industrial terminal communication.

C	DST	SRC	CMD 07	STS	TNS	FNC 05
R	SRC	DST	CMD 47	STS	TNS	

You must remove the temporary End statement from the beginning of the program and re-insert the first byte of the program.

file read (read file)

- PLC-3
- PLC-5/250

Reads data, starting at a file symbol or a block address. This starting address must point to a file of words.

C	DST	SRC	CMD 0F	STS	TNS	FNC 04	Packet Offset	Total Trans	Logical Address (2 - 51 bytes.)	Size
R	SRC	DST	CMD 4F	STS	TNS	Data - max. 244 bytes or 122 words)				

The DATA field may be replaced by an EXT STS field if there is an error.

file write (write file)



- PLC-3
- PLC-5/250

Writes data, starting at a file symbol or block address. This starting address must point to a file of words.

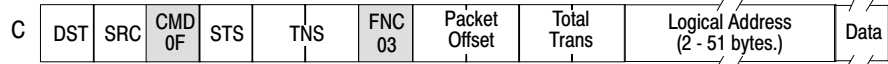

(up to [239 bytes - the PLC-3 logical address length]; must be an even number)

This reply is the same as the reply packet for all unprotected, protected, and privileged bit writes.

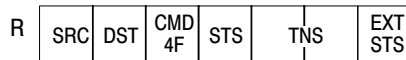

The EXT STS field may be attached to the reply packet if an error occurs.

get edit resource

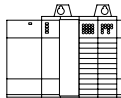

- PLC-5
- PLC-5/250 (receive only)
- PLC-5/VME
- SLC 500
- SLC 5/03
- SLC 5/04

Secures the edit resource (sole access) for the programming device. Once a programming device has obtained the edit resource, another node cannot write to or modify the device.

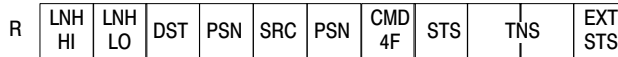
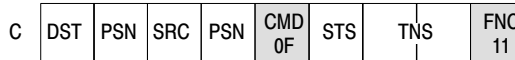

The EXT STS field may be attached to the reply packet only when there is an error.
LNH - length of the optional portion of the reply packet in bytes.



First four words of get edit resource

The first four words are currently unused and unexamined. To assure compatibility with any future use of these bytes, they should be initialized to 0. DST, PSN, and SRC are included for reference only.

For this processor	This access is cleared by
SLC 500, SLC 5/01, SLC 5/02	any node sending a <i>return edit resource</i>
SLC 5/03, SLC 5/04	the programming device or via a timed mechanism internal to the processor sending a <i>return edit resource</i>

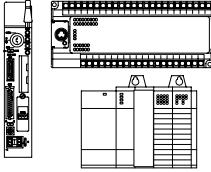
initialize memory

- MicroLogix 1000
- PLC-5
- PLC-5/250 (receive only)
- SLC 500
- SLC 5/03
- SLC 5/04

Resets the processor's memory to the default directory (the directory the processor is shipped with). Using this command does not reset the communication configuration.

C	DST	SRC	CMD 0F	STS	TNS	FNC 57
R	SRC	DST	CMD 4F	STS	TNS	EXT STS

The EXT STS field may be attached to the reply packet if an error occurs.

modify PLC-2 compatibility file

- PLC-5

Changes the compatibility mode file so that communication from a PLC-2 processor (or a node emulating a PLC-2 processor) at the given node address uses the file specified. This change in the default file for PLC-2 compatibility mode remains in effect until this command is issued again to change it or until memory is cleared. Cycling the power to the PLC-5 processor does not reset the default.

The link ID and node address are one byte each. The file number is two bytes.

C	DST	SRC	CMD 0F	STS	TNS	FNC 5E	Link ID	Node Addr	File number
R	SRC	DST	CMD 4F	STS	TNS	EXT STS			

The EXT STS field may be attached to the reply packet if there is an error.

open file

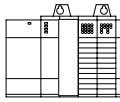

- SLC 500
- SLC 5/03
- SLC 5/04

Opens a file in an SLC 500 processor. If the file is successfully opened, a Tag (low byte, high byte) is returned.

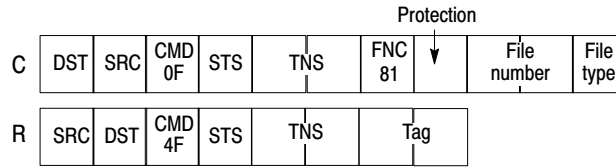

Protection - 01h = read
02h = not supported
03h = read/write

Tag is used to access the open file using a *protected type file read* or *protected type file write*. Tag is also used to close the file. The Tag field may be replaced by an EXT STS field if there is an error.

physical read



- 1774-PLC
- PLC-2
- PLC-3

Uploads data from the PLC data table or program memory.

1774-PLC and PLC-2

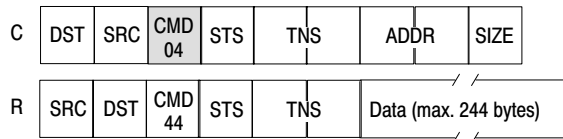

Use the SIZE field to specify the number of bytes to be read. To specify a number of PLC words, SIZE should be an even value because PLC words are two bytes.

PLC-3

For PLC-3 processors, the destination interface module accepts this command only after the source node has successfully transmitted a shutdown request.

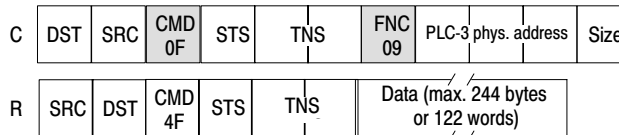

This command must request an even number of bytes.
The EXT STS field may replace the DATA field if there is an error.



- PLC-2
- 1774-PLC
- PLC-3

physical write

Downloads data into the PLC data table or program memory. Use this command to download the contents of a computer file into PLC memory.

PLC-2

For PLC-2 processors, *enter download mode* must precede the first *physical write*.

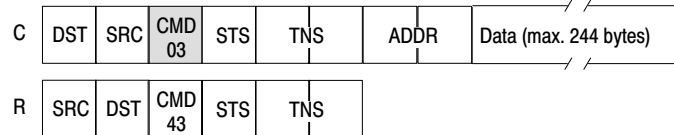

1774-PLC

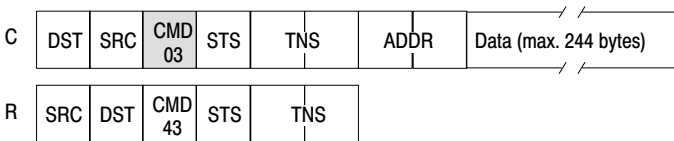

PLC-3

The starting address is a PLC-3 physical address. The destination interface module accepts this command *after* the source node has successfully transmitted a shutdown request.

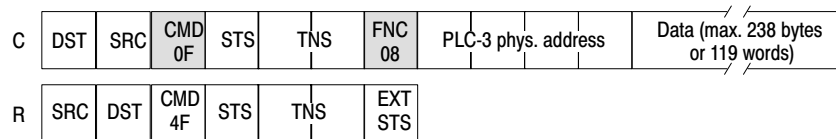

The EXT STS field may be attached to the reply packet only when there is an error.

protected bit write



- 1774-PLC
- PLC-2
- PLC-3
- PLC-5
- PLC-5/250

Sets or resets individual bits within limited areas of the PLC data table memory. The access is limited by memory access rungs in the communication zone of the PLC processor’s ladder diagram program.

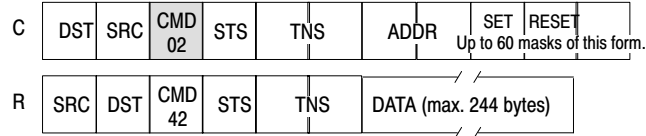

DATA	ADDR	SET	RESET
<p>DATA is:</p> <ul style="list-style-type: none"> • 4-byte blocks, each of which contains a 16-bit address field • a set mask • a reset mask 	<ul style="list-style-type: none"> • Use ADDR to specify the address of the byte to be modified in the PLC data table memory. • Put the low byte (least significant bits) of the PLC address value into the first byte of the ADDR field. 	<ul style="list-style-type: none"> • Use SET to specify which bits to set to 1 in the addressed PLC byte. • A 1 in the SET bit position means to set the corresponding bit in the addressed PLC byte to 1. • A 0 in the SET bit position means to leave the corresponding bit in the PLC byte unchanged. 	<ul style="list-style-type: none"> • Use RESET to specify which bits to reset to 0 in the addressed PLC byte. • A 1 in a RESET bit position means to reset the corresponding bit in the addressed PLC byte to 0. • A 0 in the RESET bit position means to leave the corresponding bit in the PLC byte unchanged.

Important: For some PLC processors, the interface module at the receiving PLC node executes this command by making a copy of the addressed PLC byte. It then sets or resets the appropriate bits and writes the byte back into PLC memory. At the same time, the PLC processor can change the states of the original bits in memory. Because of this, some data bits may unintentionally get overwritten.

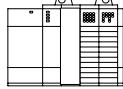
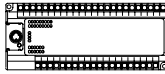
protected typed file read

- MicroLogix 1000
- SLC 500
- SLC 5/03
- SLC 5/04

Reads data from an open file in a MicroLogix 1000 or an SLC 500 processor.

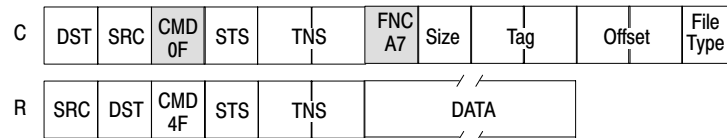

Offset is the word offset into the file (low byte, then high byte).
Size is the size of data to read:

For this processor	Valid range for Size (in bytes)
MicroLogix 1000	0-248
SLC 500, SLC 5/01, SLC 5/02	0-96
SLC 5/03, SLC 5/04	0-225 with internet protocol
	0-236 without internet protocol

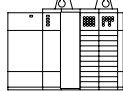
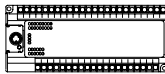
protected typed file write

- MicroLogix 1000
- SLC 500
- SLC 5/03
- SLC 5/04

Writes data to an open file in a MicroLogix 1000 or an SLC processor. For MicroLogix 1000 processors, this command can be used to update the Terminal ID by writing two bytes. (To do this, size = 02h, the tag = 4176, the offset = 0000, the file type = 90, and the two bytes of data contain the terminal ID, low byte first.)

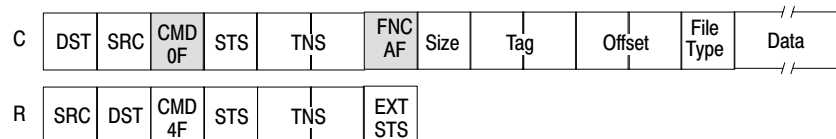

Offset is the word offset into the file (low byte, then high byte).
Size is the size of data to read:

For this processor	Valid range for Size (in bytes)
MicroLogix 1000	0-241
SLC 500, SLC 5/01, SLC 5/02	0-89
SLC 5/03, SLC 5/04	0-218 with internet protocol
	0-229 without internet protocol

protected typed logical read with three address fields

Reads data from a logical address in a SLC 500 module.

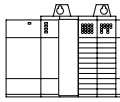

- SLC 500
- SLC 5/03
- SLC 5/04

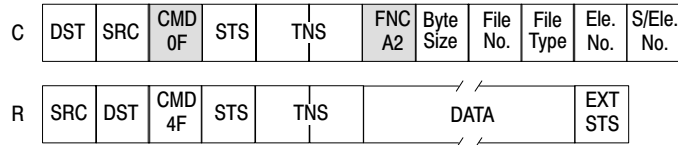

Field	Description
Byte Size	The size of data to be read (in bytes), not including the address fields or other overhead bytes.
File Number	Addresses files 0-254 only. For higher addresses, setting this byte to FF expands this field to three bytes total. Use the second and third bytes for the expanded file address (low address byte first).
File Type	Use one of the these values for this field. Do not use any other values; doing so may result in unpredictable results. <ul style="list-style-type: none"> •80-83 hex: reserved •84 hex: status •85 hex: bit •86 hex: timer •87 hex: counter •88 hex: control •89 hex: integer •8A hex: floating point •8B hex: output logical by slot •8C hex: input logical by slot •8D hex: string •8E hex: ASCII •8F hex: BCD
Element Number	Addresses elements 0-254 only. For higher addresses, setting this byte to FF expands this field to three bytes. Use the second and third bytes for the expanded element address (low address byte first).
Sub-element Number	Addresses sub-elements 0-254 only. For higher addresses, setting this byte to FF expands this field to three bytes. Use the second and third bytes for the expanded sub-element address (low address byte first).
DATA	<ul style="list-style-type: none"> •For SLC 5/01 or 5/02 = 82 bytes (41 words). •For SLC 5/03 or 5/04 <ul style="list-style-type: none"> = 225 bytes with IP (does not apply to DF1 drivers) = 236 bytes without IP (applies to DF1 drivers)

protected typed logical write with three address fields

Writes data to a logical address in a SLC processor.

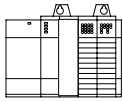

- SLC 500
- SLC 5/03
- SLC 5/04

C	DST	SRC	CMD 0F	STS	TNS	FNC AA	Byte Size	File No.	File Type	Ele. No.	S/Ele. No.	DATA
R	SRC	DST	CMD 4F	STS	TNS	EXT STS						

The EXT STS field is only included if there is an error.

Field	Description
Byte Size	The size of data to be read (in bytes), not including the address fields or other overhead bytes.
File Number	Addresses files 0-254 only. For higher addresses, setting this byte to FF expands this field to three bytes total. Use the second and third bytes for the expanded file address (low address byte first).
File Type	Use one of the these values for this field. Do not use any other values; doing so may result in unpredictable results. <ul style="list-style-type: none"> •80-83 hex: reserved •84 hex: status •85 hex: bit •86 hex: timer •87 hex: counter •88 hex: control •89 hex: integer •8A hex: floating point •8D hex: string •8E hex: ASCII
Element Number	Addresses elements 0-254 only. For higher addresses, setting this byte to FF expands this field to three bytes. Use the second and third bytes for the expanded element address (low address byte first).
Sub-element Number	Addresses sub-elements 0-254 only. For higher addresses, setting this byte to FF expands this field to three bytes. Use the second and third bytes for the expanded sub-element address (low address byte first).
DATA	<ul style="list-style-type: none"> •For SLC 5/01 or SLC 5/02 = 82 bytes (41 words) •For SLC 5/03 or 5/04 = 223 bytes with IP (does not apply to DF1 drivers) = 234 bytes without IP (applies to DF1 drivers)

protected write



- 1774-PLC
- PLC-2
- PLC-3
- PLC-5
- PLC-5/250

Writes words of data into limited areas of the PLC data table memory. Its access is limited by memory access rungs in the communication zone of the processor's ladder diagram program.

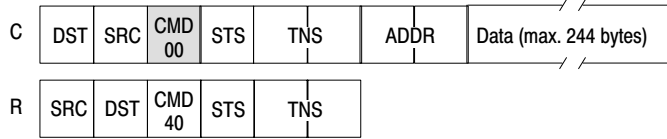

read bytes physical (physical read)



- PLC-5
- PLC-5/250 (receive only)
- PLC-5/VME

Performs an upload after receiving a reply that an *upload (download) all request* has been successfully performed.

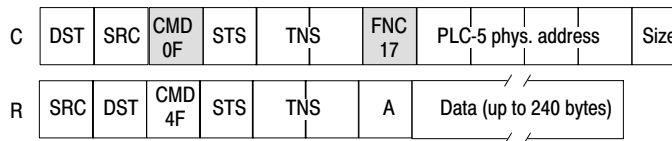

Size - the number of bytes to read, up to 240 (must be an even number).

A - extended status byte if there is an error. Otherwise, it will be data at physical address, first word, low byte.

read diagnostic counters

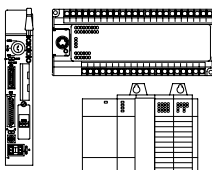

- 1774-PLC
- MicroLogix 1000
- PLC-2
- PLC-3
- PLC-5
- PLC-5/250 (receive only)
- SLC 500
- SLC 5/03
- SLC 5/04

Reads up to 244 bytes of data from the PROM or RAM of an interface module. Use this command to read a module's diagnostic timers and counters.

You must use *diagnostic status* to obtain the starting address of the diagnostic counters, except for the PLC-5, PLC-5/250, and SLC 500 processors. PLC-5 and PLC-5/250 processors don't require that this address be specified, though you must include a dummy value in the ADDR field, which the PLC-5 or PLC-5/250 processor ignores. For SLC 500 processors, zero is the only valid value for the ADDR field. (For listings of *read diagnostic counters* status information, see Chapter 10, "Diagnostic Status Information.")

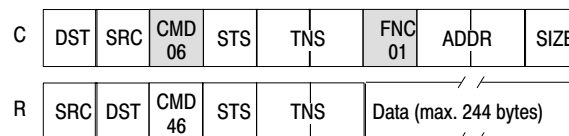

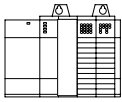
read link parameters

- SLC 500
- SLC 5/03
- SLC 5/04
(Channel 0
configured for
DH485)

Reads the DH485 parameter, Maximum Solicit Address.

This parameter specifies the maximum node address that a DH485 node tries to solicit onto the link.

C	DST	SRC	CMD 06	STS	TNS	FNC 09	Address 0000	Size 01
R	SRC	DST	CMD 46	STS	TNS	Data		

Data – the maximum node address that can be solicited (1 byte).

read modify-write (write bit)

- PLC-5
- PLC-5/VME

Sets or resets specified bits in specified words of data table memory. The interface that receives this command performs this procedure for each PLC-5 system address, AND Mask, and OR Mask in the message packet:

1. Copies the specified word in the data table.
2. Resets the bits specified in the AND mask.
3. Sets the bits specified in the OR mask.
4. Writes the word back to its location.

C	DST	SRC	CMD 0F	STS	TNS	FNC 26	PLC-5 sys. address	AND Mask	OR Mask
							(Repeatable up to 243 bytes)		
R	SRC	DST	CMD 4F	STS	TNS	EXT STS			

The EXT STS field may be attached to the reply packet only when there is an error.

The PLC-5 system address specifies the word that is modified. Use more than one field to specify more than one word. Must point to a word, and can be either a logical binary address or a logical ASCII address.

Each PLC-5 system address is followed by an AND Mask (specifies which bits in the word to reset [0]) and OR Mask. (specifies which bits in the word to set [1]). These three fields can be repeated up to a length of 243 bytes.

AND and OR Masks: two bytes each with the low byte first.

- AND Mask: 0 to reset a bit, 1 to leave it the same.
- OR Mask: 1 to set a bit, 0 to leave it the same.

Important: The controller may change the states of the original bits in memory before this command can write the word back to memory. (Some data bits may unintentionally be overwritten.) To help prevent this, we suggest that you use this command to write into the storage area of a programmable controller's data table, and have the controller read the word only, not control it.



- PLC-5/250 ONLY

read-modify-write N

Sets or resets specified bits in specified words of data table memory. The variable N lets you specify the number of sets modified. The interface that receives this command performs this procedure for each PLC-5 system address, AND Mask, and OR Mask in the message packet:

1. Copies the specified word in the data table.
2. Resets the bits specified in the AND mask.
3. Sets the bits specified in the OR mask.
4. Writes the word back to its location.

Important: The controller may change the states of the original bits in memory before this command can write the word back to memory. (Some data bits may unintentionally be overwritten.) To help prevent this, we suggest that you use this command to write into the storage area of a programmable controller’s data table, and have the controller read the word only, not control it.

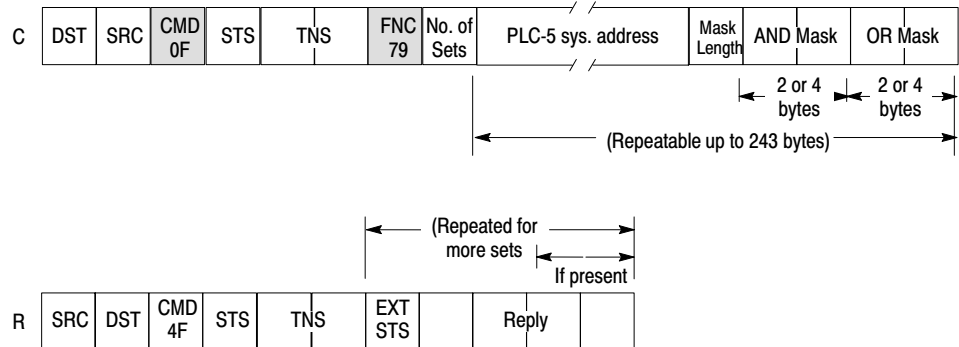

The EXT STS field may be attached to the reply packet only when there is an error. Reply includes low word, low byte and low word, high byte. Optionally, includes high word, low byte and high word, high byte.

The PLC-5 system address specifies the word that is modified. Use more than one field to specify more than one word. Must point to a word, and can be either a logical binary address or a logical ASCII address.

Each PLC-5 system address field is followed by:

- Mask Length — indicates the lengths of AND Mask and OR Masks
- AND Mask — specifies which bits in the word to reset; 0 to reset a bit, 1 to leave it the same
- OR Mask — specifies which bits in the word to set ; 1 to set a bit, 0 to leave it the same

These three fields, along with the PLC-5 system address field, can be repeated up to a length of 243 bytes.

read section size



- PLC-3
- PLC-5

Reads the size of the section most fully addressed by the system address given. The size represents the size of the memory addressed most fully expressed in words. If the address is more general than a file address, the size also includes the overhead memory used to maintain the file structure. If the address specifies a file, user data is returned.

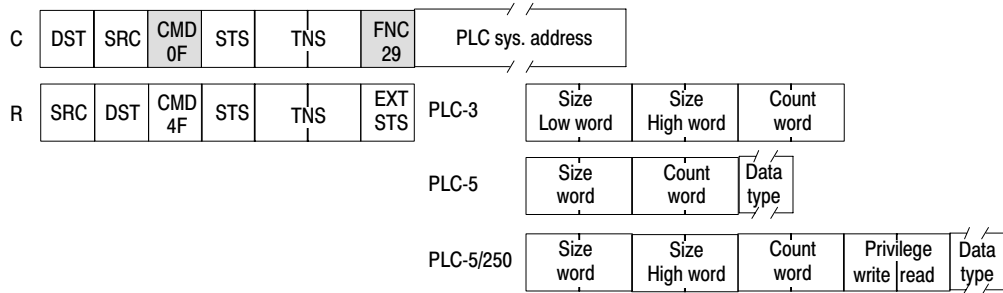

The EXT STS field may be attached to the reply packet only when there is an error.

Important: Some PLC-5 processors return the PLC-5/250 format.

reset diagnostic counters

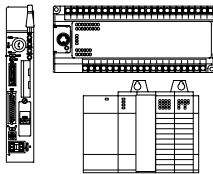

- 1774-PLC
- MicroLogix 1000
- PLC-2
- PLC-3
- PLC-5
- SLC 500
- SLC 5/03
- SLC 5/04

Resets all the diagnostic timers and counters in the node interface module = 0.

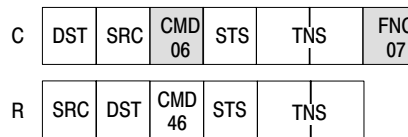



- PLC-3

restart request (restart)

Terminates an upload or a download. The computer cannot issue this command until after it has successfully completed an upload or download operation with the destination node. This command causes the interface module to revoke the upload and download privileges for the source computer node and to initialize a PLC-3 restart.

C	DST	SRC	CMD 0F	STS	TNS	FNC 0A
R	SRC	DST	CMD 4F	STS	TNS	EXT STS

The EXT STS field may be attached to the reply packet only when there is an error.

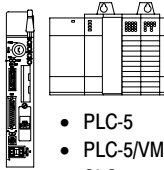

- PLC-5
- PLC-5/VME
- SLC 500
- SLC 5/03
- SLC 5/04

return edit resource

Returns the edit resource (sole access) of the processor when editing is completed. When you return the edit resource, the programming device can be written to or modified.

C	DST	PSN	SRC	PSN	CMD 0F	STS	TNS	FNC 12H		
R	LNH HI	LNH LO	DST	PSN	SRC	PSN	CMD 4F	STS	TNS	EXT STS

LNH – length of the optional portion of the reply packet in bytes.



First four words of *return edit resource*

The first four words are currently unused and unexamined. To assure compatibility with any future use of these bytes, they should be initialized to 0. DST, PSN, and SRC are included for reference only.

For this processor	This access is cleared by
SLC 5/00, SLC 5/01, SLC 5/02	any node sending this command
SLC 5/03, SLC 5/04	the programming device or via a timed mechanism internal to the processor sending this command

set data table size



- PLC-2

Sets the data table size for the PLC-2 processor. Use this command immediately before any *physical writes* on the PLC-2 processor. The *enter download mode* command must precede this command.

C	DST	SRC	CMD 06	STS	TNS	FNC 08	DATA
R	SRC	DST	CMD 46	STS	TNS		

DATA – enter the number of bytes of memory that you want to allocate to the PLC-2 data table. Since PLC words are two bytes long, the DATA value is double the number of words in the PLC-2 data table.

If < 512 bytes, the number must be a multiple of 4.

If ≥ 512 bytes the number must be a multiple of 128.

DATA is also equivalent to the physical address of the start of the processor's program memory. To determine allowable data table sizes, see the appropriate programming manual

Important: Using a data table size that is larger than the processor's available memory causes a PLC-2 fault the next time the processor is put into Run or Remote Run mode.

set ENQs



- PLC-2
- PLC-3
- PLC-5

Sets the maximum number of ENQs that the asynchronous interface module issues per message transmission. Put the number in the DATA field. The default setting for most modules is 10 ENQs per transmission (3 ENQs for the 1771-KG and 1771-KE, 9 ENQs for the 1785-KE).

C	DST	SRC	CMD 06	STS	TNS	FNC 06	DATA
R	SRC	DST	CMD 46	STS	TNS		

set link parameters

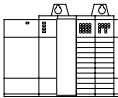

- SLC 500
- SLC 5/03
- SLC 5/04
(Channel 0 configured for DH485)

Sets the DH485 parameter, Maximum Solicit Address. This parameter specifies the maximum node address that a DH485 node tries to solicit onto the link.

C	DST	SRC	CMD 06	STS	TNS	FNC 0A	Address 0000	Size 01	Data
R	SRC	DST	CMD 46	STS	TNS				

Data - the maximum node address that can be solicited (1 byte).

set NAKs



- PLC-2
- PLC-3
- PLC-5

Sets the maximum number of NAKs (negative acknowledgements) that the asynchronous interface module accepts per message transmission. Put the number in the DATA field. The default setting for most modules is 3 NAKs per transmission.

C	DST	SRC	CMD 06	STS	TNS	FNC 05	DATA
R	SRC	DST	CMD 46	STS	TNS		



• PLC-5

set CPU mode

Sets the operating mode of the processor at the next I/O scan. The operating mode is set to the mode indicated in the flag byte (shown below). A “no privilege” error is returned if the requester does not have the privilege of placing the host in Download mode. This error occurs when:

- the processor is not in Remote mode (must be in Remote Program mode, Remote Run mode, or Remote Test mode)
- the processor is being edited
- some other node is already downloading to the processor

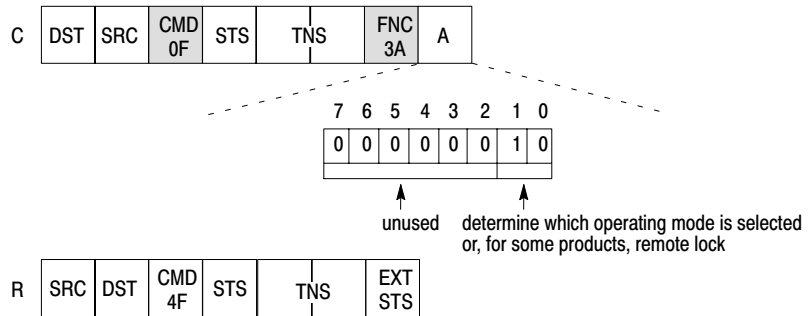

The EXT STS field may be attached to the reply packet only when there is an error.

For this operating mode	A is
Program/Load (processor idle, I/O disabled)	00000000
Remote Test (processor scanning, I/O disabled)	00000001
Remote Run (processor scanning, I/O enabled)	00000010
No change (only remote bit affected)	00000011

set timeout



- PLC-2
- PLC-3
- PLC-5

Sets the maximum amount of time that the asynchronous interface module waits for an acknowledgment to its message transmission. The setting is expressed as the number of cycles of an internal clock. (For example, 40 cycles equals 1 second for the 1770-KF2.)

C	DST	SRC	CMD 06	STS	TNS	FNC 04	DATA
R	SRC	DST	CMD 46	STS	TNS		

See the following table for settings and defaults for the module you are setting. Put the number of desired cycles in the DATA field.

DATA:

Module	Cycles/Sec	Default
1770-KF2	40	128 cycles (approx. 3 sec)
1771-KE/KF	40	128 cycles (approx. 3 sec)
1771-KG	38	38 cycles (approx. 1 sec)
1771-KGM	63	63 cycles (approx. 1 sec)
1775-KA	40	128 cycles (approx. 3 sec)
1785-KE	29	128 cycles (approx. 4.5 sec)

set variables



- PLC-2
- PLC-3
- PLC-5

Sets the maximum ENQs, NAKs, and timeout all at once. This command is a combination of the *set NAKs*, *set CPU mode*, and *set timeout* commands.

C	DST	SRC	CMD 06	STS	TNS	FNC 02	DATA (3 bytes)
R	SRC	DST	CMD 46	STS	TNS		

DATA - Put the timeout setting in the first byte, the NAKs setting in the second byte, and the ENQs in the third byte.

shutdown



- PLC-3

Asks the interface module to initiate either a PLC-3 shutdown (if the computer has download privileges) or a freeze on file allocations (if the computer has upload privileges). The computer cannot issue this command until it has successfully transmitted an upload or download request to the module.

C	DST	SRC	CMD 0F	STS	TNS	FNC 07
R	SRC	DST	CMD 4F	STS	TNS	EXT STS

The EXT STS field may be attached to the reply packet only when there is an error.

typed read (read block)



- PLC-5
- PLC-5/VME
- SLC 5/03
- SLC 5/04

Reads a block of data from the processor starting at the PLC-5 system address plus the packet offset.

C	DST	SRC	CMD 0F	STS	TNS	FNC 68	Packet Offset	Total Trans	PLC-5 sys. address	Size
R	SRC	DST	CMD 4F	STS	TNS	A	B			

Size - number of elements to read from the specified system address.

A - Type/data parameter. Used to specify

- type of data you are writing or reading
- size in bytes of each piece of data you are writing or reading

B - Data (up to 240 bytes minus the number of bytes used in the type/data parameter).

An EXT STS byte will replace A and B if there is an error. The first byte of the type/data parameter is the flag byte, and has this format:

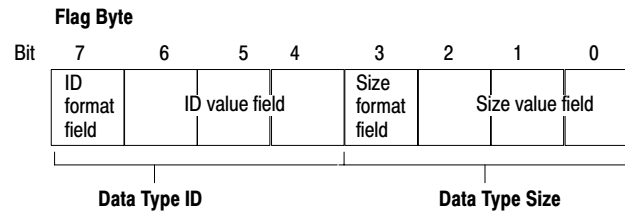

Data Type ID (Bits 4-7)		Data Type Size (Bits 0-3)	
The following table contains a list of the types of data you can read and write and the ID value of each:		If the data type defined in the ID Value field uses	Then enter
Data Type ID	Type of Data	7 or fewer bytes for each piece of data	zero (0) in bit 3 of the flag byte. Enter the actual number of bytes used for each element of data in bits 0, 1, and 2 (Size Value Field).
1 2 3 4 5 6 7 8 9 15 16	bit bit string byte (or character) string integer Allen-Bradley timer Allen-Bradley counter Allen-Bradley general control structure IEEE floating point array of similar elements address data binary-coded decimal (BCD)	more than 7 bytes for each element of data	one (1) in bit 3 of the flag byte. In bits 0, 1, and 2, you enter the number of bytes that will contain the number of bytes used for each element of data. These additional size value bytes follow the flag byte and any ID Type bytes.
If the Data Type ID is		For example, if each element of data used 8 bytes, then you set bit 3 to 1 (because the value 8 cannot fit into bits 0, 1, and 2). Bits two, one, and zero would be set to 0, 0, 1 (respectively), to signify that the number of bytes per element of data (8) will be contained in one byte that follows the flag byte and any ID Type bytes.	
7 or less	zero (0), and encode the ID value for the data type in the bits 4, 5, and 6 (ID Value Field).		
greater than 7	one (1). In bits 4, 5, and 6, you insert the number of bytes to follow that contain the data type ID value (usually 1). These additional ID value bytes follow directly after the flag byte.		
For example, if you were sending address data, then bit 7 would be set to 1 (because the address ID value 15 cannot fit into bits 4, 5, and 6). Bits six, five, and four would be set to 0, 0, 1 (respectively), to signify that the data ID value (15) will be contained in one byte that follows the flag byte.			

For examples of type/data parameter, see page 7-36.

typed write (write block)

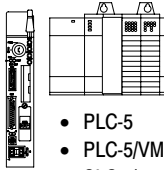

- PLC-5
- PLC-5/VME
- SLC 5/03
- SLC 5/04

Writes a block of data to the processor starting at the PLC-5 system address plus the packet offset. The type of data sent with the *typed write* command must match the data type of the file to which it is being written. If not, the remote host returns an error reply.

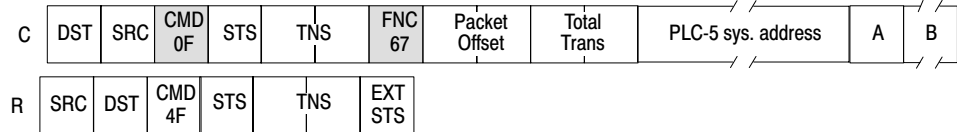

A - Type/data parameter

B - Data (up to 240 bytes minus the number of bytes used in the PLC-5 system address and the type/data parameter.)

An EXT STS byte will replace A and B if there is an error.

For packet offset, total transaction, and size (in elements) low byte is first.

The PLC-5 system address can be a logical binary address or a logical ASCII address that contains up to 51 bytes of specification.

The EXT STS field may be attached to the reply packet only when there is an error.

unprotected bit write



- 1774-PLC
- PLC-2
- PLC-3
- PLC-5

Sets or resets individual bits in any area of PLC data table memory.

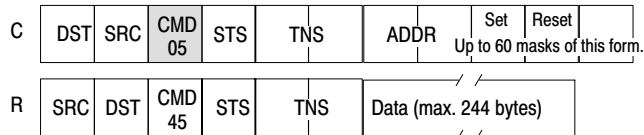

DATA	ADDR	SET	RESET
<p>DATA is:</p> <ul style="list-style-type: none"> • 4-byte blocks, each of which contains a 16-bit address field • a set mask • a reset mask 	<ul style="list-style-type: none"> • Use ADDR to specify the address of the byte to be modified in the PLC data table memory. • Put the low byte (least significant bits) of the PLC address value into the first byte of the ADDR field. 	<ul style="list-style-type: none"> • Use SET to specify which bits to set to 1 in the addressed PLC byte. • A 1 in a bit position of the SET mask means to set the corresponding bit in the addressed PLC byte to 1. • A 0 in a bit position of the SET mask means to leave the corresponding bit in the PLC byte unchanged. 	<ul style="list-style-type: none"> • Use RESET to specify which bits to reset to 0 in the addressed PLC byte. • A 1 in a bit position of the RESET mask means to reset the corresponding bit in the addressed PLC byte to 0. • A 0 in a bit position of the RESET mask means to leave the corresponding bit in the PLC byte unchanged.

Important: The interface module at the receiving PLC node executes this command by first making a copy of the addressed PLC byte. It then sets or resets the appropriate bits and writes the byte back into PLC memory. At the same time, the PLC processor can be changing the states of the original bits in memory. Because of this, some data bits may unintentionally be overwritten.

unprotected read

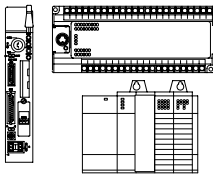

- 1774-PLC
- PLC-2
- PLC-3
- PLC-5
- SLC 500
- SLC 5/03
- SLC 5/04
- MicroLogix 1000

1774-PLC, PLC-2, PLC-3, PLC-5

Reads words of data from any area of PLC and PLC-2 data table memory. In PLC-3 and PLC-5 processors, the data is read from the PLC-2 compatibility file. Use the SIZE field to specify the number of bytes to be read. To specify a number of PLC words, SIZE should be an even value because PLC words are two bytes long. Data bytes are transferred low byte first. The address of a word should be even.

C	DST	SRC	CMD 01	STS	TNS	ADDR	SIZE
R	SRC	DST	CMD 41	STS	TNS	DATA (max. 244 bytes)	

SLC 500, MicroLogix 1000

Reads data from a common interface file (CIF). The SLC 500 CIF is data file number 9, the MicroLogix 1000 CIF is integer file 7. This command is implemented as a protected file read in SLC processors and is used by non-SLC 500 devices to read information from SLC 500 devices.

C	DST	SRC	CMD 01	STS	TNS	ADDR	SIZE
R	SRC	DST	CMD 41	STS	TNS	DATA	

Address - Logical offset into the CIF.

SLC 500, SLC 5/01 and SLC 5/02 (SLC 5/02 prior to series C FRN 3) processors use word addressing
 SLC 5/02 series C FRN 3 and later, SLC 5/03, and SLC 5/04 processors select word or byte addressing
 for S:2/8 = 0 (default) — word addressing is used
 for S:2/8 = 1 — byte addressing is used

Size - Number of bytes to read starting from the offset.

for SLC 500, SLC 5/01 and SLC 5/02 processors: valid range is 0 - 95 bytes (odd or even)
 for SLC 5/03 and SLC 5/04 processors - with internet protocol: valid range is 0 - 225 bytes (odd or even)
 - without internet protocol: valid range is 0 - 236 bytes (odd or even)

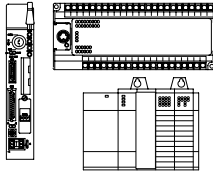
unprotected write

- 1774-PLC
- PLC-2
- PLC-3
- PLC-5
- SLC 500
- MicroLogix 1000

1774-PLC, PLC-2, PLC-3, PLC-5

Writes words of data into any area of PLC and PLC-2 data table memory. In PLC-3 and PLC-5 processors, the data is written into the PLC-2 compatibility file.

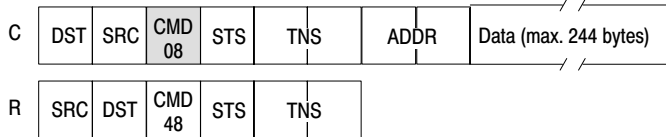
**SLC 500, MicroLogix 1000**

Writes data to a common interface file (CIF). The SLC CIF is data file number 9; the MicroLogix CIF is integer file 7.

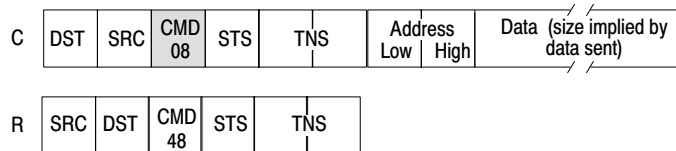

Address – Logical offset into the CIF. Value is in words or bytes as shown below:

SLC 500, SLC 5/01 and SLC 5/02 (SLC 5/02 prior to series C FRN 3) processors use word addressing
 SLC 5/02 series C FRN 3 and later, SLC 5/03, and SLC 5/04 processors select word or byte addressing
 for S:2/8 = 0 (default) — word addressing is used
 for S:2/8 = 1 — byte addressing is used

Data – Data to be written. This size of the data is implied by the number of data bytes sent.

for SLC 500, SLC 5/01 and SLC 5/02 processors: valid range is 0 - 94 bytes (odd or even)
 for SLC 5/03 and 5/04 processors – with internet protocol: valid range is 0 - 223 bytes (odd or even)
 without internet protocol: valid range is 0 - 234 bytes (odd or even)



- PLC-5
- PLC-5/VME

upload all request (upload)

Places a PLC-5 processor in Upload mode before uploading a complete system. (A T50 terminal displays “download” mode.)

A “no privilege“ error is returned if the programmed device does not have the privilege of placing the processor into Upload mode.

This error occurs when:

- the processor is being edited
- some other node is already uploading or downloading to the processor

If you have an earlier version of a PLC-5 processor, this error may occur if your processor is not in Program or Remote Program mode.

C

DST	SRC	CMD 0F	STS	TNS	FNC 53
-----	-----	-----------	-----	-----	-----------

R **PLC-5/15 Series A and Series B Revision E and earlier**

SRC	DST	CMD 4F	STS	TNS	EXT STS
-----	-----	-----------	-----	-----	------------

PLC-5/15 Series B Revision F and later and all other PLC-5 family processors

SRC	DST	CMD 4F	STS	TNS	A	B	C	D
-----	-----	-----------	-----	-----	---	---	---	---

The EXT STS field may be attached to the reply packet only when there is an error.

A – number of uploadable segments of PLC-5 memory in the remote PLC-5 processor

B – (eight bytes for each segment specified in A.) First 4 bytes contain the starting address of the segment. The second 4 bytes contain the ending address of the segment.

C – number of comparable memory segments.

D – (eight bytes for each segment specified in C.) The first four bytes contain the starting address of the segment. The second four bytes contain the ending address of the segment.

A, B, C, D – These fields may be replaced by an EXT STS field if there is an error.

If you are using a PLC-5 family processor other than a PLC-5/15 (Series A or Series B Revision E or earlier), you also receive data about uploadable and comparable memory segments:

Segment	Description
uploadable memory	Contiguous segments of the PLC-5 memory that must be uploaded.
comparable memory	Uploadable contiguous memory segments that you can compare to an uploaded segment to verify the contents. For example, a segment of memory that contains ladder logic is comparable, but a segment that contains data table memory is not because because data table memory is constantly changing.

upload completed



- PLC-5
- PLC-5/VME

After uploading a complete system, use to return the processor to the mode it was in prior to executing the *upload all request* command.

C	DST	SRC	CMD 0F	STS	TNS	FNC 55
R	SRC	DST	CMD 4F	STS	TNS	EXT STS

The EXT STS field may be attached to the reply packet only when there is an error.

upload



- PLC-3

Informs the interface module that it wants to perform an upload. If the module grants the upload privilege, the computer issues *physical reads*. If another node already has the upload privilege, the second node is denied the privilege.

C	DST	SRC	CMD 0F	STS	TNS	FNC 06
R	SRC	DST	CMD 4F	STS	TNS	EXT STS

The EXT STS field may be attached to the reply packet only when there is an error.

word range read (read block)



- PLC-3
- PLC-5

Reads a word or file starting at a specified address. A special case of this command is a single-word read, where the number of bytes to read is only two bytes (one word). This command must always be an even number of bytes.

C	DST	SRC	CMD 0F	STS	TNS	FNC 01	Packet Offset	Total Trans	PLC sys. address	Size
R	SRC	DST	CMD 4F	STS	Data - max. 244 bytes or 122 words)					

The DATA field may be replaced by an EXT STS field if there is an error.

For this processor	The starting address can be a
PLC-3	word symbol, file symbol plus a word offset, or a block address. The starting address must point to a word in a file.
PLC-5	logical binary address or a logical ASCII address of up to 51 bytes.

word range write (write block)



- PLC-3
- PLC-5

Writes to a word or file starting at a specified address. A special case of this command is the single-word write, where the data field is only one word long.

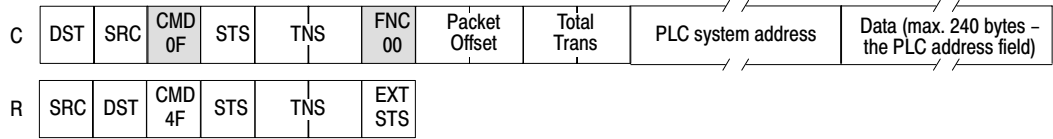

The EXT STS field may be attached to the reply packet only when there is an error.

For this processor	The starting address can be a
PLC-3	word symbol, file symbol plus a word offset, or a block address. The starting address must point to a word in a file.
PLC-5	logical binary address or a logical ASCII address of up to 51 bytes.

write bytes physical (physical write)



- PLC-5
- PLC-5/VME

Performs a download only after receiving a reply that the *download* (or *upload*) *all request* has been successfully performed.

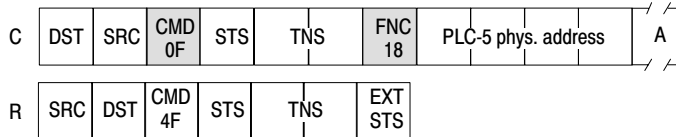

The EXT STS field may be attached to the reply packet only when there is an error.

PLC-5 physical address - contains the address you are writing to.

A - Up to 238 bytes can be written with a single command (low byte of the word first). (Must be an even number of data bytes.)

PLC-5 Type/Data Parameter Examples

The type/data parameter is a variable length field. The most significant bit of each nibble determines additional bytes used. The value of this field can be extended to a 7-byte unsigned integer. The bytes are ordered least to most significant. All zero most-significant bytes are permitted, but the fields generated by them are no different than those that omit these insignificant bytes. The following three descriptors are all permitted and equivalent:

Important: Your software must be able to handle all three cases.

Case 1	Case 2	Case 3
0100 0011	0100 1001	0100 1010
0100 0011	0000 0011	0000 0011
		0000 0000

These all have an ID value of 4 and a size value of 3.

Example 1: Type/data parameter for writing or reading integer data

This example shows the type/data parameter for writing or reading integer (ID = 4) data, with each element of data 2 bytes long.

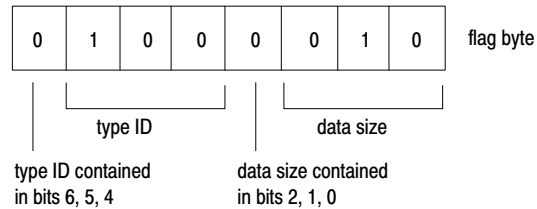

Example 2: Type/data parameter for writing or reading integer data

This example shows the type/data parameter for reading an array (ID = 9). The array data type includes an additional byte called the descriptor byte, located after the ID byte. The descriptor byte is a second flag byte which describes the type of data in the array. You include the descriptor byte as part of the data field size.

Bit 76543210

flag byte	10010111	Bits 4 – 7: Data Type ID in next one byte Bits 0 – 3: bytes per data type equals seven (6 data bytes plus 1 descriptor)
	00001001	ID Value = 9 (array)
	01000010	Integer descriptor, size = 2 bytes each
	00000000	Integer 0, (LS) Value = 0
	00000000	(MS)
	11111110	Integer 1, (LS) Value = -2
	11111111	(MS)
	11111111	Integer 2, (LS) Value = 255
	00000000	(MS)

Not all sizes are legal for all formats. The “B” data type always has a size value of one. The “F” data type has either a size value of four (single precision) or eight (double precision). Each of the Allen-Bradley predefined structures has a fixed size.

Example 3: PLC-5 processor requesting I0 integer words

10011010	Bits 4 – 7: Data Type ID in next byte Bits 0 – 3: Size encoded in next two bytes after type
00001001	ID Value = 9 (array)
00010101	Extended size = 15 _{hex} = 21 First byte of extended size (LS)
00000000	21 = one byte for type and twenty bytes of data to follow Second byte of extended size (MS)
01000010	Bits 4 – 7: Data Type = 4 = integer Bits 0 – 3: Size = two bytes per element

SLC 500 Information

Important: There are also some limitations on the basic commands SLC 500 family nodes support:

Command	Limitation
Diagnostic Loop	Maximum data field size is 95 bytes, not 243.
Unprotected Read	Maximum data field size is 95 bytes, not 244. In addition, the Addr field is used as a word address instead of a byte address, and the Size field may contain either an even or odd value.
Unprotected Write	Maximum data field size is 94 bytes, not 244. In addition, the Addr field is used as a word address instead of a byte address.

Reading and Writing SLC 500 Data

When using SLC terminology:

- The address field in the *unprotected read* and *unprotected write* commands is used as the word offset into the file
- Thus, to read N9:9 from an SLC 500, put 9 in the address field (after converting it to 09 hex)

Reading and Writing SLC 500 Data (using PLC-2 terminology)

Important: The address fields of *unprotected reads* and *unprotected writes* are used as **word** addresses instead of the **byte** addresses used in the PLC-2, 1774-PLC, and PLC-5 processor. Because of this, existing software drivers that communicate with these processors do not work with SLC 500 family processors, unless you set bit S:2/8 to a logical one. The SLC 500 processor then changes to byte addressing mode. This bit is reset to logical zero by default.

You can map the SLC 500 CIF file to PLC-2 memory as shown in the following example. The maximum size of PLC-2 memory that you can simulate is 256 words (octal 00 through 377).

Example: Reading SLC 500 data using SLC and PLC-2 terminology

SLC Logical Address	High Byte	Low Byte	Octal Address
N9:0	Byte #1	Byte #0	000
N9:1	Byte #3	Byte #2	001
N9:2	Byte #5	Byte #4	002
N9:3	Byte #7	Byte #6	003
N9:4	Byte #9	Byte #8	004
N9:5	Byte #11	Byte #10	005
N9:6	Byte #13	Byte #12	006
N9:7	Byte #15	Byte #14	007
N9:8	Byte #17	Byte #16	010
N9:9	Byte #19	Byte #18	011
N9:10	Byte #21	Byte #20	012
.	.	.	.
.	.	.	.
.	.	.	.
N9:255	Byte #511	Byte #510	377

PLC-2
Memory Map

Example: Reading the 18th and 19th bytes shown in the example on page 7-39

These examples compare two methods for reading SLC 500 data—from an SLC 500 (assumes S:2/8 = 0 so that word addressing is selected) and from a PLC-2 processor. When using the SLC 500 method, you do not multiply by two (as in step 2, below) as you do with the PLC-2 method.

Read N9:9 from SLC 500 processor:

1. Convert decimal element to hex:

9 (decimal) → 0009 (hex)

2. Put low byte first in address field:

Address	Size
09 00h	xxh

3. Put 02 (hex) in size field (2 bytes = 1 word):

Address	Size
09 00h	02h

Read octal word 011 from PLC-2 processor:

1. Convert octal element to hex:

11 (octal) → 0009 (hex)

2. Multiply by 2:

0009h x 2 = 0012h

3. Put low byte first in address field:

Address	Size
12 00h	xxh

4. Put 02 (hex) in size field (2 bytes = 1 word):

Address	Size
12 00h	02h

Message Packet Status Codes (STS, EXT STS)

Use this chapter to help interpret status codes that appear in asynchronous link message packets. You use **asynchronous-link status codes** to determine the status of a command sent from your computer to another device on your DH, DH+, or DH485 link. Asynchronous link status codes are passed in the message packet in these bytes:

- status (STS) byte
- extended status (EXT STS) byte (for some commands)

This chapter contains these sections:

Section	Page
STS Byte	8-2
EXT STS Byte	8-3
Remote STS and EXT STS Codes	8-5

STS Byte

The STS byte provides information about the execution or failure of the corresponding command that was transmitted from the computer. If the reply returns a code of 00, the command was executed at the remote node. All other codes can be divided into two types:

This error type	Occurs when
local	the local node is unable to transmit a message to the remote node. The local node interface turns the command around, stuffs the STS byte with the appropriate code, and returns it to the computer.
remote	the command is successfully transmitted to a remote node, but the remote node is unable to execute the command. The remote node formats a reply message with the appropriate remote error code in the STS byte.

The STS byte is divided into two nibbles (4 bits each):

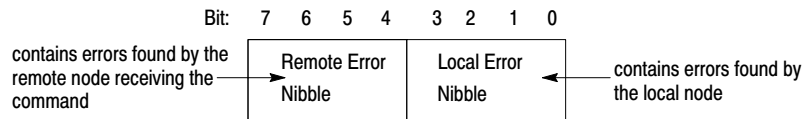

Local STS Error Codes

The local STS error code nibble contains errors found by the local node. Error codes (in hex) that you may find in the local error code nibble include:

Code	Explanation
00	Success—no error
01	DST node is out of buffer space
02	Cannot guarantee delivery: link layer (The remote node specified does not ACK command.)
03	Duplicate token holder detected
04	Local port is disconnected
05	Application layer timed out waiting for a response
06	Duplicate node detected
07	Station is offline
08	Hardware fault

Local STS codes 09 through 0F (hex) are not used.

Remote STS Error Codes

The remote STS error code nibble contains errors found by the remote node receiving the command. Error codes (in hex) that you may find in the remote error code nibble of the STS byte include:

Code	Explanation
00	Success—no error
10	Illegal command or format
20	Host has a problem and will not communicate
30	Remote node host is missing, disconnected, or shut down
40	Host could not complete function due to hardware fault
50	Addressing problem or memory protect rungs
60	Function not allowed due to command protection selection
70	Processor is in Program mode
80	Compatibility mode file missing or communication zone problem
90	Remote node cannot buffer command
A0	Wait ACK (1775-KA buffer full)
B0	Remote node problem due to download
C0	Wait ACK (1775-KA buffer full)
D0	Not used
E0	Not used
F0	Error code in the EXT STS byte

EXT STS Byte

You have an EXT STS byte if your STS code is F0 (hex). Definitions for this byte vary, depending on the command code (or type of command) in your message packet:

CMD code (hex)	Type of code in EXT STS byte	Refer to
00 to 08	No EXT STS byte	not applicable
0F	DH/DH+ codes	page 8-4
0B, 1A, or 1B	DH485 codes	page 8-5

EXT STS Codes for CMD 0F	
Hex Code	Explanation
0	Not used
1	A field has an illegal value
2	Less levels specified in address than minimum for any address
3	More levels specified in address than system supports
4	Symbol not found
5	Symbol is of improper format
6	Address doesn't point to something usable
7	File is wrong size
8	Cannot complete request, situation has changed since the start of the command
9	Data or file is too large
A	Transaction size plus word address is too large
B	Access denied, improper privilege
C	Condition cannot be generated - resource is not available
D	Condition already exists - resource is already available
E	Command cannot be executed
F	Histogram overflow
10	No access
11	Illegal data type
12	Invalid parameter or invalid data
13	Address reference exists to deleted area
14	Command execution failure for unknown reason; possible PLC-3 histogram overflow
15	Data conversion error
16	Scanner not able to communicate with 1771 rack adapter
17	Type mismatch
18	1771 module response was not valid
19	Duplicated label
22	Remote rack fault
23	Timeout
24	Unknown error
<i>These codes are for passthru from a DH+ link to a remote I/O link.</i>	
1A	File is open; another node owns it
1B	Another node is the program owner
1C	Reserved
1D	Reserved
1E	Data table element protection violation
1F	Temporary internal problem

DH485 EXT STS Codes

Hex Code	Explanation
07H	Insufficient memory module size (0000h is returned)
0BH	Access denied, privilege violation
0CH	Resource not available or can not do
0EH	CMD can not be executed
12H	Invalid parameter
14H	Failure during processing
19H	Duplicate label
1AH	File open by another node + owner's local node address, 1 byte
1BH	Program owned by another node + program owner's local node address, 1 byte

Remote STS and EXT STS Codes

For these codes	See
remote STS codes from a PLC-2 or 1774-PLC processor	section below
remote STS and EXT STS codes from a PLC-3 processor	page 8-6

Remote STS Codes from a PLC-2 or 1774-PLC Processor

STS codes that may be sent from your PLC-2 (or 1774-PLC) processor to your computer include:

STS Code	Explanation ^①
10	The command message (command code, sub-command code, size of the command or requested reply size) was incorrect.
20	There are verification errors within the host PLC processor.
30	A condition exists at the PLC-2 processor that requires manual intervention, such as: <ul style="list-style-type: none"> • the cable between the module and the processor is unplugged • the processor is faulted
40	A communication error on the cable or on backplane access between the module, and the processor has aborted message execution.
50	An attempt to access an illegal address in the PLC-2 processor has aborted message execution. Illegal access may result from access outside: <ul style="list-style-type: none"> • the data table as defined by the PLC-2 • a memory access window (protected commands only) Illegal access may also mean that the PLC-2 processor has attempted to communicate with a PLC-3, PLC-5, or an SLC 500 processors that does not have the proper compatibility file.
60	Execution of a command at the PLC-2 processor is disabled by a switch option.
70	The PLC-2 processor is in Program or Remote Program mode, or the 1771-KA is in Download mode. Alternatively, this code can also mean that the PLC-2 processor is not in Program or Remote Program mode.
80	Execution of protected commands at the PLC-2 processor is inhibited because its PROG light is on.

^① The error sets the remote error bit for the associated rung.

Remote STS and EXT STS Codes from a PLC-3 Processor

A PLC-3 interface module (1775-KA,-S5,-SR5) inserts the reply error code in the STS byte of any reply message packet it returns to a remote node (your computer).

The meaning of each error code depends on the command message received from the computer. The following pages describe the error conditions that the various commands can generate. The error codes are listed according to the decimal value that is stored at the computer.

When a remote node transmits one of these commands, the local PLC-3 interface module may issue a reply message that contains one of the error codes listed under that command. Error codes contained in the EXT STS bytes are only available if either another PLC-3 or computer originates the command message.

Command	EXT STS Code	STS Code	Explanation
<i>diagnostic read</i>	-	10	<ul style="list-style-type: none"> • A two-byte ADDR field and a one-byte SIZE field are missing after the FNC byte in the command message. • The number of bytes of data requested in the SIZE field is greater than the maximum number allowed per reply packet (244), or SIZE is 0.
	-	50	The command is an illegal request to read from the PLC-3 interface module's backplane window.
<i>diagnostic status</i>	-	40	A backplane error occurred during determination of the physical address of the end of the ladder diagram program or of the end of user memory.
PLC/PLC-2 word write	-	10	<ul style="list-style-type: none"> • A two-byte ADDR field is expected after the TNS word, but only one byte is present. • There is an odd number of data bytes in the command packet. • The ADDR value is odd (that is, it does not specify a word address).
	-	30	The local PLC-3 interface module has executed a shutdown request to the local PLC-3 processor.
	-	40	Local PLC-3 backplane error (either memory parity, timeout, or disconnect).
	-	50	<ul style="list-style-type: none"> • The destination file does not exist in PLC-3 memory. • The destination word does not exist in the destination PLC-3 file. • The length of the destination file is greater than 65,535 words.
	-	60	Local keyswitch setting prohibits writing into desired destination file.
	-	70	The local PLC-3 processor is in Program mode. There may be a major system fault.

Command	EXT STS Code	STS Code	Explanation
PLC/PLC-2 read	-	10	<ul style="list-style-type: none"> •The required two-byte ADDR field and one-byte SIZE field are missing in the command message. •The ADDR value is odd (that is, it does not specify a word address). •The value of SIZE is 0. •The value of SIZE is greater than 244. •The SIZE value specifies an odd number of bytes.
	-	30	The local PLC-3 interface module has executed a shutdown request to the local PLC-3 processor.
	-	40	Local PLC-3 backplane error (either memory parity, timeout, or disconnect).
	-	50	<ul style="list-style-type: none"> •A destination (DST) file does not exist. •The DST file is too small. •The source (SRC) file is more than 65,535 words long.
	-	70	PLC-3 processor is in Program mode.
PLC/PLC-2 bit write	-	10	Incomplete bit description because the number of bytes after the TNS word is not a multiple of 4.
	-	30	The local PLC-3 interface module has executed a shutdown request to the local PLC-3 processor.
	-	40	Local PLC-3 backplane error (either memory parity or timeout/disconnect).
	-	50	<ul style="list-style-type: none"> •A DST file does not exist. •The DST bits do not exist in the destination file. •Length of the SRC file is greater than 65,535 words.
	-	60	The keyswitch setting at local PLC-3 processor prohibits access.
	-	70	The local PLC-3 processor is in Program mode.

Command	EXT STS Code	STS Code	Explanation
PLC-3 word write	-	10	<ul style="list-style-type: none"> There are not at least two bytes of data after the end of the block address. There is an odd number of data bytes after the end of the block address. The sum of packet offset and size values specifies more than 65,535 words. The sum of packet offset and size is greater than total transaction size.
	-	30	The local PLC-3 interface module has executed a shutdown request.
	-	40	A backplane error (either memory parity, timeout, or disconnect) has occurred.
	-	60	The processor keyswitch setting does not allow access.
	-	70	The local PLC-3 processor is in Program mode.
	1	F0	There is an error in converting the block address (major section > 63, context >15, or section >15).
	2	F0	Three or fewer addressing levels specified for a PLC-3 word address.
	3	F0	The conversion of a file address to a block address resulted in more than nine addressing levels.
	4	F0	The symbolic address was not found.
	5	F0	The symbolic address is of length zero or is longer than eight bytes.
	6	F0	<ul style="list-style-type: none"> The DST file was not found. The DST address does not point to a word (for <i>word-range writes</i>) or a file (for <i>file writes</i>). The DST address specifies more levels than required. The first word of the DST location does not exist.
	7	F0	<ul style="list-style-type: none"> Any word in the total transaction does not exist in the DST file. For a <i>file write</i>, the SRC and DST files are not the same size.
	8	F0	The DST file size changed between packets of a multi-packet transaction and became too small for the total transaction.
	9	F0	There are more than 65,535 words in the SRC file.
	A	F0	The sum of total transaction size and the word level PLC-3 addressing is greater than 65,535.
B	F0	The source node does not have access to the DST file.	

Command	EXT STS Code	STS Code	Explanation
PLC-3 <i>physical reads</i>	-	10	<ul style="list-style-type: none"> • There is more than one byte of data after the byte address. • The number of bytes to read: <ul style="list-style-type: none"> - is an odd number. - equals zero. - is greater than the maximum allowed in a reply packet (244). • The sum of packet offset and size of data in words is greater than 65,535. • The sum of packet offset and size of data in words is greater than the total transaction size.
	-	30	The local PLC-3 interface module has executed a shutdown request.
	-	40	A backplane error (memory parity, timeout, or disconnect) has occurred.
	-	70	The local PLC-3 processor is in Program mode.
	1	F0	There was an error converting the block address (major section > 63, context > 15, section > 15).
	2	F0	Three or fewer addressing levels specified for a PLC-3 word address.
	3	F0	The conversion of a file address to a block address resulted in more than nine addressing levels.
	4	F0	The symbolic address was not found.
	5	F0	The symbolic address is zero or more than eight bytes.
	6	F0	<ul style="list-style-type: none"> • The file was not found. • DST address does not have enough levels to specify a PLC-3 word (for <i>word-range reads</i>) or a file (for <i>file reads</i>). • The PLC-3 address specifies more levels than required. • The word specified by the PLC-3 address does not exist.
	7	F0	<ul style="list-style-type: none"> • Any of the DST words in the DST file do not exist. • For a <i>file read</i>, the SRC and DST files are not the same size.
	8	F0	The file size decreased between packets of a multi-packet transaction and became too small for the total transaction.
	9	F0	You tried to read or write past the end of a file.
A	F0	Start bytes.	

Command	EXT STS Code	STS Code	Explanation
PLC-3 bit write	-	10	More than four bytes of data exist after the PLC-3 address in the command message.
	-	30	The local PLC-3 interface module has executed a shutdown request.
	-	40	A backplane error (memory parity, timeout, or disconnect) has occurred.
	-	60	The keyswitch setting does not allow access to file.
	-	70	The local PLC-3 in the Program mode.
	1	F0	There was an error in converting the block address (major section > 63, context > 15, section > 15).
	2	F0	Three or fewer addressing levels specified for a PLC-3 word address.
	3	F0	Conversion of a file address to a block address resulted in more than 9 addressing levels.
	4	F0	The symbolic address was not found.
	5	F0	The symbolic address is zero or more than eight bytes.
	6	F0	<ul style="list-style-type: none"> • File not found. • The DST address does not specify a PLC-3 word. • The PLC-3 address specifies more levels than required. • The word specified by the PLC-3 address does not exist.
	9	F0	The file is larger than 65,535 words.
	B	F0	The remote node does not have access to the DST file.

■ **Module Diagnostics** ■

Diagnostic Counters — Chapter 9

Diagnostic Status Information — Chapter 10

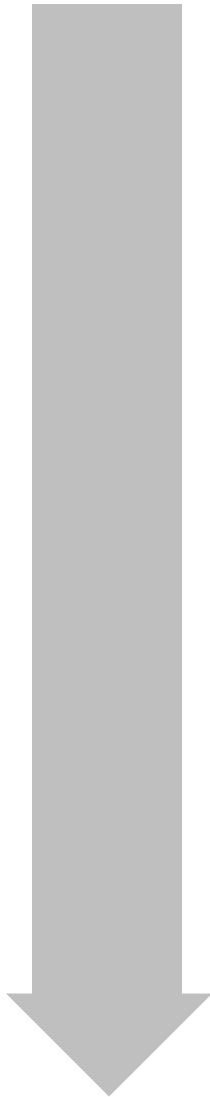

Diagnostic Counters

Diagnostic counters are bytes of information stored in RAM in each module. The counters occupy a block of the module's internal scratch RAM. Most are single-byte counters that wrap around to zero when they overflow. They are used to record events that can be used in debugging and long-term reliability analysis.

These counters provide a useful tool for diagnosing problems. For example, the ACK timeout counter and the false poll counter are useful for diagnosing bad cabling, a noisy link, or an overloaded link installation. You can also use the counters to determine the ratio of messages transmitted (successfully returned an ACK from the remote node) versus the commands sent.

This chapter lists interface module diagnostic counters and describes what they contain. It contains these sections:

Section	Page
1747 Cat. Nos.	9-3
1761 Cat. Nos.	9-7
1770 Cat. Nos.	9-8
1771 Cat. Nos.	9-14
1775 Cat. Nos.	9-21
1779 Cat. Nos.	9-24
1784 Cat. Nos.	9-25
1785 Cat. Nos.	9-26
5250 Cat. Nos.	9-33



Reading diagnostic counters

To read diagnostic counters, you issue a *diagnostic read* command from a device that:

- is connected to an interface module that supports an asynchronous port
- can format the diagnostic commands

(Therefore, a PLC user program is unable to initiate a diagnostic command.)

An interface module's diagnostic counter location varies:

- by module type
- between revision levels of the same type module

You first request the location of these counters by transmitting a *diagnostic status* command to the module. (For more on *diagnostic status*, see page 7-6.) Based on the address returned, you can use the number of the counters which follow as an offset to calculate:

- the location of the desired counter
- how many counter values you want returned

You can then use this information to format a *diagnostic read* command. The reply from the *diagnostic read* command contains the data stored in the counters. For the PLC-5 and SLC 500 processors, you format the *diagnostic read* command with a dummy value for the address. The reply contains the entire counter block. (For more on *diagnostic read*, see page 7-19.)

1747 Cat. Nos.

Cat. Nos.	Link	Pages
1747-KE	DH485	9-3
1747-L20, -L30, -L40, -L511, -L514, -L524, -L532 ^①	DH485	9-3
1747-L541, -L542, -L542 ^②	DH+	9-4
	DH485	9-5
1747-L541, -L542, -L542 ^②	DF1	9-6

^① SLC 500, 5/01, and 5/02 processors

^② SLC 5/03 and 5/04 processors

1747-KE DH485 Diagnostic Counters

This counter byte	Counts the number of
0	Total message packets received, low byte
1	Total message packets received, high byte
2	Total message packets sent, low byte
3	Total message packets sent, high byte
4	Message packet retries
5	Retry limit exceeded (non-delivery)
6	NAK, no memory sent
7	NAK, no memory received
8	Total bad message packets received
9	Reserved

1747-L20, -L30, -L40, -L511, -L514, -L524, (SLC 500, 5/01, and 5/02 processors), 1747-PA2x (SLC APS COM1), 1770-KF3, and 1784-KR DH485 Diagnostic Counters

This counter byte	Counts the number of
0	Total message packets received, low byte
1	Total message packets received, high byte
2	Total message packets sent, low byte
3	Total message packets sent, high byte
4	Message packet retries
5	Retry limit exceeded
6	NAK, no memory sent
7	NAK, no memory received
8	Total bad message packets received
9	Bad messages due to illegal type

1747-L541, -L542, and -L543 (SLC 5/04 processors) DH+ Diagnostic Counters

This counter byte	Counts the number of
0, 1	Messages received
2, 3	Messages sent
4, 5	Messages received with errors
6, 7	Messages sent with errors
8, 9	Messages unable to receive
10, 11	Network dead
12, 13	Claims won
14, 15	Claims lost
16, 17	New successor
18, 19	Token retry
20, 21	Token failed
22, 23	Started linear scan
24, 25	Linear scan failed
26, 27	Duplicate node
28, 29	Dropped token
30, 31	Received SDA
32, 33	Received bad packets
34, 35	Received SDA re-transmission
36, 37	Received SDA but full
38, 39	Received SDA SAP off
40, 41	Transmit SDA confirm
42, 43	Transmit SDA NAK misc
44, 45	Transmit SDA timeout
46, 47	Transmit SDA not ACKed
48, 49	Transmit SDA retry
50, 51	Transmit SDA failed
52, 53	Transmit SDA NAKed (full)
54, 55	Transmit SDA NAKed inactive SAP
56, 57	Transmit SDN confirm
58, 59	Transmit SDN failed
60, 61	Solicit rotations
62, 63	Receive SDN

1747-L541, -L542, and -L543 (SLC 5/03 and 5/04 processors) DH485 Diagnostic Counters

This counter byte	Counts the number of
0	Total message packets received, low byte
1	Total message packets received, high byte
2	Total message packets sent, low byte
3	Total message packets sent, high byte
4	Message packet retries
5	Retry limit exceeded
6	NAK, no memory sent
7	NAK, no memory received
8	Total bad message packets received
9	Bad messages due to illegal type (i.e., control byte bad)
10	Bad messages due to bad CRC
11	Bad messages due to character with parity error
12	Bad messages due to character with framing error
13	Bad messages due to overrun error
14	Number of unexpected characters received ^①

^① If this counter is not zero, it could indicate that an internal hardware problem has occurred. This problem could be that the communication channel's receiver has been disabled, but the DH485 driver is still receiving characters. If the controller is operating properly, this counter should remain at zero.

1747-L541, -L542, and -L543 (SLC 5/03 and SLC 5/04 processors) DF1 Diagnostic Counters

This counter byte	Counts the number of
0, 1	RS-232 modem line status: <ul style="list-style-type: none"> • Bit 0 = CTS input line status • Bit 1 = RTS output line status • Bit 2 = DSR input line status • Bit 3 = DCD input line status • Bit 4 = DTR output line status
2, 3	Total message packets sent
4, 5	Total message packets received
6, 7	Undelivered message packets
8, 9	Message packets retried
10, 11	Normal station poll list last scan time (100 ms increments)
12, 13	Normal station poll list maximum scan time (100 ms increments)
14, 15	Non-response due to bad message packets detected
16, 17	Unused
18, 19	Duplicate message packets received
20, 21	Priority station poll list last scan time (100 ms increments)
22, 23	DCD recovery field (times DCD toggled off and on)
24, 25	Lost modem field (times modem has been disconnected)
26, 27	Priority station poll list maximum scan time (100 ms increments)

1761 Cat. Nos.

Cat. Nos.	Link	Pages
1761-L16AWA, -L16BBB, -L16BWB, -L32AWA, -L32BWA, -L32BWB	DH485	9-7
	DF1	9-7

1761-L16AWA, -L16BBB, -L16BWB, -L32AWA, -L32BWA, -L32BWB (MicroLogix 1000 processors, Series C or later) DH485 Diagnostic Counters

This counter byte	Counts the number of
0	Total message packets received, low byte
1	Total message packets received, high byte
2	Total message packets sent, low byte
3	Total message packets sent, high byte
4	Message packet retries
5	Retry limit exceeded
6	NAK, no memory sent
7	NAK, no memory received
8	Total bad message packets received
9	Reserved

1761-L16AWA, -L16BBB, -L16BWB, -L32AWA, -L32BWA, -L32BWB (MicroLogix 1000 processors) DF1 Diagnostic Counters

This counter byte	Counts the number of
0, 1	Unused
2, 3	Message packets sent
4, 5	Message packets received
6, 7	Messages undelivered
8, 9	ENQ packets sent
10, 11	NAK packets received
12, 13	ENQ packets received
14, 15	Bad message packets received NAKed
16, 17	Out of memory NAKed
18, 19	Duplicate message packets
20, 21	Framing errors detected
22, 23	Unused
24, 25	Unused

1770 Cat. Nos.

Cat. Nos.	Link	Pages
1770-KF2	DH	9-8
	DH+	9-11
1770-KF3	DH485	9-3
1770-KFC	DF1	9-13

1770-KF2 and 1771-KE/KF DH and Asynchronous Link Diagnostic Counters

This counter byte	Counts the number of
0	Bad CRCs or I/O errors on ACK. Same causes as bad CRC on messages.
1	Times the sender timed out waiting for an acknowledgment. This is a common error and is the first to respond to reflections or low level noise on the link. It is sensitive to problems on longer cables. It also appears if the receiver or transmitter circuitry on a module is marginal or if the cable connections are loose.
2	Times contention was detected. This counter corresponds to error 93. This also appears quickly on noisy or over-length cables.
3	Times the ACK was successfully received but contained a non-zero status code other than memory full. Currently the only other implemented ACK code is buffer overflow. This condition should never occur except when debugging new computer programs.
4	Times the link driver returns a message to sender. Each count corresponds to one local error bit set or one reply message lost.
5	Times the link driver returns a message to sender. Each time this happens, the message is placed on a waiting queue for 0.5s. Each message is re-tried five times before it is returned to the sender.
6	Times this node grabbed mastership of the link because it timed out while waiting to hear a valid frame. On a DH link that has just been powered up, there should be only one node that has this counter incremented.
7	Times that this node has tried to relinquish mastership and the node that was expected to takeover failed to respond. This happens often on a noisy link because the noise is mistaken for a poll response, and the wrong node is selected as the next master. When this occurs the old master resumes polling. It also can happen on a long link if the poll response is very attenuated and is not picked up by the carrier detect circuit. If the new node does respond but the old master does not hear it, the old master records a false poll and continues polling, and the new master starts polling. This usually leads to the second node detecting contention and relinquishing.
8	Times that the receiver received a status frame instead of a message frame. This counter is never incremented because the message size is checked first, and all status messages are too small to be accepted.

This counter byte	Counts the number of
9	<p>Frames that were rejected because they were less than 6 bytes long.</p> <p>This counter records all status frames that were received by a node that disabled its address recognizer in the second step of the mastership timeout process. This happens often on a heavily-loaded link.</p>
10	<p>Frames that were rejected because the destination address was incorrect.</p> <p>This can have the same cause as counter byte 9. This counter also detects frames that have the same source and destination address.</p>
11	<p>Times that the receiver sent an ACK without first being able to allocate a receive buffer.</p> <p>This may result in a memory overflow error when the next message is received.</p>
12	<p>Frames that were rejected because of a bad CRC.</p> <p>This error is common on a noisy link.</p>
13	<p>Times a message was received that contained more than 250 bytes.</p>
14	<p>Times a message was received when buffer space was not allocated for it.</p> <p>This usually follows a "memory full" error.</p>
15	<p>Duplicate frames received.</p> <p>A duplicate frame is sent by a transmitter when it fails to receive an ACK. If the reason it failed to receive an ACK was that the ACK was lost—rather than because the original message was lost—the duplicate is redundant and should be discarded. Any two successive messages between polls that have the same sequence number fields and the same command or reply bits are assumed to be duplicates.</p>
16	<p>Aborts received.</p> <p>The HDLC abort signal is not used on a DH link but can be detected by the serial input or output, in certain circumstances. Some nodes whose addresses match the ringing pattern after a transmitter shutoff can be particularly susceptible to this error (nodes 36, 76, and 176, for example). These numbers depend on highway configurations.</p>
17, 18	<p>Messages successfully transmitted.</p>
19, 20	<p>Messages successfully received.</p>

This counter byte	Counts the number of
21, 22	Times the node attempted to send a message.
23, 24	Messages were successfully transmitted and ACKed.
25, 26	ACKs received.
27	ACKs successfully passed from the receiver's separator to the transmitter.
28	NAKs received.
29	NAKs passed from the separator to the transmitter.
30	Timeouts waiting for a response.
31	ENQs sent.
32	Messages that could not be successfully sent.
33	Reply messages that could not be forwarded and were destroyed.
34, 35	Messages received.
36, 37	ACKs sent.
38	NAKs sent.
39	ENQs received.
40	Re-transmissions received and ACKed. A re-transmission is a message that has a transparent word, command, and source that match the previous message.
41	STX (full-duplex mode) or SOH (half-duplex mode) received. This is a count of the number of messages that were started.
42	Messages, characters, or message fragments that were ignored.
43	Messages aborted by receipt of a DLE ENQ.
44	Messages aborted by the receipt of an unexpected control code other than DLE ENQ.
45	Times the DLE ACK response was sent but there was no buffer space for the next message.
46	DLE NAK was sent because there was no buffer.
47	Broadcast messages received.
48	Broadcast messages that were successfully received.
49	Messages seen that were not for this node.
50	DLE EOTs sent.
51	Calls received.
52	Times the phone was hung up by the module.
53	DCD was lost.
54	Times the phone was hung up because of a DCD timeout.

1770-KF2 and 1785-KE DH+ and Asynchronous Link Diagnostic Counters

This counter byte	Counts the number of
0	Times received ACK with bad CRC.
1	Times timeout expired with no ACK received.
2	Transmit re-tries exhausted.
3	NAK/illegal protocol operation received.
4	NAK/bad LSAP received.
5	NAK/no memory received.
6	Received ACK/NAK too short.
7	Received ACK/NAK too long
8	Something other than an ACK/NAK received.
9	Token pass timeouts.
10	Token pass re-tries exhausted.
11	Claim token sequence entered.
12	Tokens claimed.
13	Bad CRCs in received frame.
14	NAK/illegal protocol operations sent.
15	NAK/bad LSAPs sent.
16	NAK/no memory sent.
17	Received frame too small.
18	Received frame too long.
19	Received a re-transmission of a frame.
20	Received frame aborted (line noise).
21, 22	Messages successfully sent (low byte first).
23, 24	Messages successfully received (low byte first).
25, 26	Commands successfully sent (low byte first).
27, 28	Replies successfully received (low byte first).
29, 30	Commands successfully received (low byte first).
31, 32	Replies successfully sent (low byte first).
33	Replies could not be sent.
34	Active nodes.

This counter byte	Counts the number of
35, 36	Times node attempted to send a message.
37, 38	Messages that were successfully transmitted and ACKed.
39, 40	ACKs that were received.
41	ACKs successfully passed from the receiver's separator to the transmitter.
42	NAKs received.
43	NAKs passed from the separator to the transmitter.
44	Timeouts waiting for a response.
45	ENQs sent.
46	Messages that could not be successfully sent.
47	Reply messages that could not be forwarded and were destroyed.
48, 49	Messages received.
50, 51	ACKs sent.
52	NAKs sent.
53	ENQs received.
54	Re-transmissions received and ACKed. A re-transmission is a message that has a transaction (TNS) word, command (CMD), and source (SRC) that match the previous message.
55	STX (full-duplex mode) or SOH (half-duplex mode) received. This is a count of the number of messages that were started.
56	Messages, characters, or message fragments that were ignored.
57	Messages that were aborted by receipt of a DLE ENQ.
58	Messages that were aborted by the receipt of an unexpected control code other than DLE ENQ.
59	DLE ACK response was sent but there was no buffer space for the next message.
60	DLE NAK was sent because there was no buffer.
61	Broadcast messages received
62	Broadcast messages that were successfully received.
63	Messages seen that were not for this node.
64	DLE EOTs sent.
65	Calls received.
66	Times the phone was hung up by the module.
67	Times DCD was lost.
68	Times the phone was hung up because of a DCD timeout.

1770-KFC DF1 Diagnostic Counters

This counter byte	Counts the number of
1	Total DF1 packets received, low byte.
2	Total DF1 packets received, high byte.
3	Total DF1 packets transmitted, low byte.
4	Total DF1 packets transmitted, high byte.
5	Number of DF1 retries.
6	Number of DF1 packets where the retry limit was exceeded.
7	Number of DF1 NAKs sent.
8	Number of DF1 NAKs received.
9	Number of DF1 bad messages received.
10	Number of RS-232 line errors
11	Total good ControlNet packets received, low byte.
12	Total good ControlNet packets received, high byte.
13	Total bad ControlNet packets received, low byte.
14	Total bad ControlNet packets received, high byte.
15	Total ControlNet packets transmitted, low byte.
16	Total ControlNet packets transmitted, high byte.

1771 Cat. Nos.

Cat. Nos.	Link	Pages
1771-KA, 1771-KA2, and 1774-KA	DH	9-14 , 9-15
1771-KC	DH	9-16 , 9-18
1771-KE/KF	DH	9-8
1771-KG, -KGM	DH	9-19

1771-KA, 1771-KA2, and 1774-KA DH Diagnostic Counters

This counter byte	Counts the number of
0	Times CRC was in error on an ACK.
1	Times the sender timed out waiting for an acknowledgement. Common error that occurs with error reflections or noise on the link (sensitive to problems on longer cables). It also shows up if the receiver or transmitter circuitry on a module is marginal, or if cable connections are loose.
2	Times contention was detected. This appears quickly on noisy or long cables. This counter corresponds to error 93. If 93 is a common error on your link, expect 37 (start bit timeout) errors also, since any reply that experiences contention is not re-tried.
3	Times the ACK was successfully received but contained a non-zero status code other than memory full. Only other implemented ACK code is buffer overflow. This condition should never occur except when debugging new code.
4	Times the link driver returns a message to sender. Each count corresponds to one local error bit set or one reply message lost.
5	Times the receiving node's memory was full. Each time this happens, the message is placed on a waiting queue for 0.5s. Each message is re-tried five times for memory overflow before it is returned to sender.
6	Times this node grabbed mastership of the DH link because it timed out while waiting to hear a valid frame. On a link that has just been powered up, there should be only one node that has this counter incremented.
7	Times this node has tried to relinquish mastership and the node that was expected to take over failed to respond. Happens on a noisy link because the noise is mistaken for a poll response, and the wrong node is selected as the next master. When this occurs, the old master resumes polling. Also happens on a long link, if the poll response is very attenuated and is not picked up by the carrier detect circuit. If the new node responds, but the old master does not hear it, the old master records a false poll and continues polling. The new master starts polling also. This usually leads to the second node detecting contention and relinquishing.
8	Times the receiver received a status frame instead of a message frame. This occurs only if a poll timeout is imminent (a master has had mastership for more than 170ms) and the node has disabled its address recognizer to test for any valid traffic.

This counter byte	Counts the number of
9	Frames that were rejected because the header was incomplete. This is counted only because of undebugged software or in the unlikely event that a bad frame fooled the CRC checker.
10	Frames that were rejected because the destination address was incorrect. This can have the same cause as counter byte 8. This counter also detects frames that have the same source and destination address.
11	Times the receiver sent an ACK without first being able to allocate a receive buffer. This results in a memory overflow error when the next message is received.
12	Frames rejected because of a bad CRC. This error is very common on a noisy DH link.
13	Times a message was received that contained more than 250 bytes.
14	Times a message was received when there was no buffer space allocated for it (usually follows a memory full error).
15	Duplicate frames received. A duplicate frame is sent by a transmitter when it fails to receive an ACK. If the reason it failed to receive an ACK was that the ACK was lost—rather than because the original message was lost—the duplicate is redundant and is discarded. Any two successive messages between polls that have the same sequence number fields and the same command or reply bits are assumed to be duplicates.
16	Aborts received. The HDLC abort signal is not used on a DH link, but can be detected by the serial input or output, in certain circumstances. Some nodes whose addresses match the ringing pattern after a transmitter shutoff are susceptible to this error (nodes 36, 76, and 176, for example). These numbers depend on highway configurations.
17, 18	Messages successfully transmitted.
19, 20	Messages successfully received.
21, 22	Command messages that were successfully generated as a result of a start bit being set and records this number. Some command messages may not be recorded because they were not successfully sent or they were sent back to the originating node.
23, 24	Command messages that were received to be executed on the link. This count does not depend on whether execution was successful. For each message counted as received a reply message is sent.
25, 26	Reply messages received that resulted in the setting of a done or remote error bit.
27	Breaks sent to the industrial terminal.
28	Times the PLC driver has to re-synchronize with the PLC processor. This counter always counts at least one re-synch (because of powerup).
29	Errors on the KA-to-IT cable (counts down module 5). Every time this count reaches zero, the 1771-KA does a handshake to reset the forced I/O table in the PLC processor.

This counter byte	Counts the number of
30	Replies lost because they could not be delivered over the DH link. Undeliverable commands can be signaled to the user, because the "user" is located in PC memory, and can always be reached. If a reply message cannot be delivered over the link, there is no way to signal the user (of that message)—who is also over the highway—that this node cannot signal a reply. The local user is not concerned with the problems of the remote user and can take no meaningful action, so there is not much to do but destroy the message and count it.

Important: An intelligent device can read the memory of the 1771-KC it is connected to by setting the destination equal to the module address.

1771-KC DH Diagnostic Counters

This counter byte	Counts the number of
0	Bad CRCs on ACK.
1	Times the sender timed out waiting for an acknowledgement. This is a common error and is one of the first to respond to reflections or low-level noise on the link. It seems to be especially sensitive to problems with longer cables. It also shows up if the cable connection are loose.
2	Times contention was detected. This also shows up quickly on noisy or cables that are too long. This counter corresponds to error 93.
3	Times the ACK was successfully received but contained a non-zero status code other than memory full.
4	Times the highway driver returns a message to sender with a non-zero status code because a reply was not received from a remote node. Each count corresponds to one local error bit set or one reply message lost.
5	Times the receiving node's memory was full. Each time this happens, the message is placed on a waiting queue for 0.5s. Each message is re-tried five times for memory overflow before it is returned to sender.
6	Times this node grabbed mastership of the highway because it timed out while waiting to hear a valid frame. On a DH link that has just been powered up, there should be only one node that has this counter incremented.
7	Times that this node has tried to relinquish mastership and the node that was expected to take over failed to respond. This happens on a noisy link because the noise is mistaken for a poll response, and the wrong node is selected as the next master. When this occurs, the old master resumes polling. It also can happen on a long link, if the poll response is very attenuated and is not picked up by the carrier detect circuit. If the new node does respond but the old master does not hear it, the old master records a false poll and continues polling, and the new master starts polling also. This usually leads to the second node detecting contention and relinquishing.

This counter byte	Counts the number of
8	<p>Times the receiver received a status frame instead of a message frame.</p> <p>This occurs if a poll timeout is imminent (a master has had mastership for more than 170ms) and the node has disabled its address recognizer to test for any valid traffic. The probability of errors in counter bytes 8, 9 and 10 increases substantially.</p>
9	<p>Frames that were rejected because the header was incomplete. This is only counted because of undebugged software or in the unlikely event that a bad frame fooled the CRC checker.</p>
10	<p>Frames that were rejected because the destination address was incorrect.</p> <p>This can have the same cause as counter byte 8. This counter also detects frames that have the same source and destination addresses.</p>
11	<p>Times that the receiver sent an ACK without first being able to allocate a receive buffer.</p> <p>This results in a memory overflow error when the next messages is received</p>
12	<p>Frames that were rejected because of a bad CRC.</p> <p>This error is common on a noisy link.</p>
13	<p>Times a message was received that contained more than 250 bytes.</p>
14	<p>Times a message was received when there was no buffer space allocated for it.</p> <p>This usually follows a "memory full" error.</p>

This counter byte	Counts the number of
15	Duplicate frames received. A duplicate frame is sent by a transmitter when it fails to receive an ACK. If the reason it failed to receive an ACK was that the ACK was lost—rather than that the original message was lost—the duplicate is redundant and is discarded. Any two successive messages between polls that have the same sequence number fields and the same command or reply bits are assumed to be duplicates.
16	Aborts received. The HDLC abort signal is not used on a DH link but can be detected by the serial input or output, in certain circumstances. Some nodes whose addresses match the ringing pattern after a transmitter shutoff, can be particularly susceptible to this error (nodes 36, 76, and 176, for example). These numbers depend on link configurations.
17, 18	Messages successfully transmitted.
19, 20	Messages successfully received.
21, 22	ACKs received.
23, 24	ACKs sent.
25, 26	NACKs received.
27, 28	NACKs sent.
29	Replies that were lost because they could not be delivered over the link. Undeliverable commands can be signalled to the user, because the “user” is located in PC memory, and can always be reached. If a reply message cannot be delivered over the link, there is no way to signal the user (of that message)—who is also on the link—that this node cannot signal a reply. The local user is not concerned with the problems of the remote user and can take no meaningful action, so there is not much to do but destroy the message and count it.
30	Timeouts preset.
31	Values set by diagnostic commands or set by default on power-up.
32	ENQs preset.

1771-KG,-KGM Diagnostic Counters

Asynchronous Link Diagnostic Counters	
This counter byte	Counts the number of
0, 1	Times a node attempted to send a message.
2, 3	Messages that were successfully transmitted and ACKed.
4, 5	ACKs that were received.
6	ACKs successfully passed from the receiver's separator to the transmitter.
7	NAKs received
8	NAKs passed from the separator to the transmitter.
9	Timeouts waiting for a response.
10	ENQs sent.
11	Messages that could not be successfully sent.
12	Reply messages that could not be forwarded and were destroyed.
13, 14	Messages received.
15, 16	ACKs sent.
17	NAKs sent.
18	ENQs received.
19	Re-transmissions received and ACKed. A re-transmission is a message that has a transparent word, command, and source that match the previous message.
20	STX (full-duplex mode) or SOH (half-duplex mode) received. This is a count of the number of messages that were started.
21	Messages, characters, or message fragments that were ignored.
22	Messages that were aborted by receipt of a DLE ENQ.
23	Messages that were aborted by the receipt of an unexpected control code other than DLE ENQ.
24	Times DLE ACK response was delayed because of a lack of buffer space for the next message.
25	Times reply was changed from ACK to NAK because unexpected characters (any besides DLE ENQ) were received while waiting for memory to free up.
26	Broadcast messages received.
27	Broadcast messages that were successfully received.
28	Messages seen that were not for this node.
29	Poll messages received for this node.
30	DLE EOTs sent.
31	Calls received.
32	Times phone was hung up by the module.
33	Times DCD was lost.
34	Times the phone was hung up because of a DCD timeout.

Internal Event Counters

This counter byte	Counts the number of
35	Messages routed to RS-232 port.
36	Commands routed to command executor.
37	Replies routed to reply processor.
38	Messages sent to self
39	Routing errors on inbound messages.
40	Routing errors on outbound messages.
41	Messages with incorrect network address.
42, 43	Messages sent by command initiator.
44, 45	Commands received by command executor.
46, 47	Replies sent by command executor.
48, 49	Replies received by command initiator.
50	Breaks sent to IT.
51	Re-syncs sent to PLC.

1775 Cat. Nos.

Cat. Nos.	Link	Pages
1775-KA ^①	DH	9-21
1775-S5, -SR5	DH+	9-21

^① PLC-3 processors

1775-KA,-S5,-SR5 DH Diagnostic Counters

DH Port Counters	
This counter byte	Counts the number of
0	Bad CRCs on acknowledgment.
1	Timeouts that occurred before an ACK was received.
2	Contentions (while master, detected message transmission by another node).
3	ACKs containing an error.
4	Returned messages (local errors and lost replies).
5	Waits (no "receive" buffer space at destination node).
6	Poll time outs (master failed).
7	False polls (failure to transfer).
8	ACKs received when not master.
9	Times the message size was too small (less than 5 bytes).
10	Incorrect DST, or SRC is equal to DST.
11	Times memory was not available for receive buffer.
12	Received messages with bad CRC value.
13	Times a message was too long.
14	Times a message arrived when there was no buffer space left.
15	Re-transmissions of a previously received message.
16	Aborts (result of line noise).
17, 18	Messages successfully transmitted.
19, 20	Messages successfully received.
21, 22	Command messages sent.
23, 24	Reply messages received.
25, 26	Command messages received.
27, 28	Reply messages sent.

Asynchronous Link Counters (1775-KA only)	
This counter byte	Counts the number of
29, 30	Command messages sent.
31, 32	Reply messages received.
33, 34	Command messages received.
35, 36	Reply messages sent.
37, 38	ACKs received.
39, 40	ACKs sent.
41, 42	NAKs received.
43, 44	NAKs sent.
45	Undeliverable reply messages.
46, 47	Computer link timeouts (preset to 500 ms).
48	NAKs accepted per message (preset to 10)—maximum number.
49	ENQs sent per message (preset to 10)—maximum number.
50	NAKs (current count).
51	ENQs (current count).

1775-S5,-SR5 DH+ Diagnostic Counters

This counter byte	Counts the number of
0, 1	Messages sent successfully.
2, 3	Message received successfully (not counting duplicate messages).
4	Undeliverable messages (message was NAKed or retries were used up).
5	ACK timeouts; sent a packet that did not get acknowledged or wait acknowledged.
6	Received NAKs.
7	Message retries as a result of CRC error, illegal length, DST not equal to this node, SRC not equal to node that message was sent to, or timeout.
8	NAKs sent - no memory was available.
9	NAKs sent - message had undefined LSAP.
10	Duplicate messages received.
11	Token pass retries.
12	Packets received that were aborted early.
13	Packets received that had a CRC error.
14	Packets received that had an illegal size (greater than 271 bytes or less than 3 bytes).
15	Duplicate tokens detected.
16	Node recoveries from duplicate node condition.
17, 18	Link dead timeouts.

1779 Cat. Nos.

Cat. Nos.	Link	Pages
1779-KP5	DH+	9-24

1779-KP5 DH+ Diagnostic Counters

This counter byte	Counts the number of
0	ACKs received with bad CRC.
1	Timeouts that expired with no ACK received.
2	Times transmit retries exhausted.
3	NAK or illegal protocol operations received.
4	NAKs – bad LSAPs received.
5	NAKs – no memory received.
6	Received ACKs/NAKs that were too short.
7	Received ACKs/NAKs that were too long.
8	Times something other than an ACK/NAK received.
9	Token pass timeouts.
10	Token pass retries exhausted.
11	Claim token entered.
12	Token claimed.
13	Bad CRC in received frame.
14	NAKs – illegal protocol operation sent.
15	NAKs – bad LSAP sent.
16	NAKs – no memory sent.
17	Received frames that were too short.
18	Received frames that were too long.
19	Times received a retransmission of a frame
20	Received frames aborted (line noise).
21, 22	Messages successfully sent (low byte first).
23, 24	Messages successfully received (low byte first).
25, 26	Commands successfully sent (low byte first).
27, 28	Replies successfully received (low byte first).
29, 20	Commands successfully received (low byte first).
31, 32	Replies successfully sent (low byte first).
33	Replies that could not be sent.
34	Number of active nodes.

1784 Cat. Nos.

Cat. Nos.	Link	Pages
1784-KR	DH485	9-3
1784-KT, -KT2	DH+	9-25

1784-KT and 1784-KT2 DH+ Diagnostic Counters

This counter byte	Counts the number of
0	Times received ACKs with a bad CRC.
1	Timeouts expired with no ACK received.
2	Transmit retries exhausted.
3	NAK or illegal protocol operations received.
4	NAKs – bad LSAP received.
5	NAK – no memory received.
6	Received ACKs/NAKs that were too short.
7	Received ACKs/NAKs that were too long.
8	Times something other than an ACK/NAK received.
9	Duplicate tokens found.
10	Token pass timeouts.
11	Token pass retries exhausted.
12	Claim token sequence entered.
13	Tokens claimed.
14	Bad CRC in received frame.
15	NAKs sent – illegal protocol operation.
16	NAK sent – bad LSAP.
17	NAK sent – no memory.
18	Received frames that were too short.
19	Received frames that were too long.
20	Re-transmissions received of a frame.
21	Received frames aborted (line noise).
22, 23	Messages successfully sent (low byte first).
24, 25	Messages successfully received (low byte first).
26, 27	Commands successfully sent (low byte first).
28, 29	Replies successfully received (low byte first).
30, 31	Commands successfully received (low byte first).
32, 33	Replies successfully sent (low byte first).
34	Replies that could not be sent (low byte first).
35	Number of active nodes.

1785 Cat. Nos.

Cat. Nos.	Link	Pages
1785-KE	DH+	9-11
1785-KA3	DH+	9-28
1785-KA	DH	9-26
1785-KA	DH+	9-27
1785-KA5	DH+	9-29
	DH485	
1785-L11B, -L20B, -L30B, -L40B, -L60B, -L80B processors	DH+	9-30
1785-L20E, -L40E, -L40L, -L60L, -L80E processors	DH+	9-32

1785-KA DH Diagnostic Counters

This counter byte	Counts the number of
0	Times received ACKs with a bad CRC.
1	Timeouts expired with no ACK received.
2	Mastership contentions.
3	Errors in received ACK.
4	Sum of bytes 1, 2, and 4.
5	WACKs received; stopped sending for a while.
6	Times the master died (assumed mastership).
7	False polls: no answer to poll of size = 1.
8	ACKs received when not master.
9	Received frames that were too small.
10	Received frames that were with SRC = DST.
11	Unused.
12	Received frames containing a bad CRC.
13	Received frames that were too long.
14	Times there was no buffer for the received message, WACK sent.
15	Frame re-transmissions received.
16	Received frames aborted (line noise).
17, 18	Messages successfully sent (low byte first).
19, 20	Messages successfully received (low byte first).
21, 22	Commands successfully sent (low byte first).
23, 24	Replies successfully received (low byte first).
25, 26	Commands successfully received (low byte first).
27, 28	Replies successfully sent (low byte first).
29	Replies that could not be sent.

1785-KA DH+ Diagnostic Counters

This counter byte	Counts the number of
0	Times received ACKs with a bad CRC.
1	Timeouts expired with no ACK received.
2	Transmit re-tries exhausted.
3	NAK/illegal protocol operations received.
4	NAK/bad LSAP received.
5	NAK/no memory received.
6	Received ACKs/NAKs too short.
7	Received ACKs/NAKs too long.
8	Times something other than an ACK/NAK received.
9	Duplicate tokens found.
10	Duplicate nodes found.
11	Token pass timeouts.
12	Token pass re-tries exhausted.
13	Claim token sequences entered.
14	Tokens claimed.
15	Bad CRC in received frames.
16	NAKs - illegal protocol operations sent.
17	NAKs - bad LSAP sent.
18	NAKs - no memory sent.
19	Received frames that were too small.
20	Received frames that were too long.
21	Frame re-transmissions received.
22	Received frames aborted (line noise).
23, 24	Messages successfully sent (low byte first).
25, 26	Messages successfully received (low byte first).
27, 28	Commands successfully sent (low byte first).
29, 30	Replies successfully received (low byte first).
31, 32	Commands successfully received (low byte first).
33, 34	Replies successfully sent (low byte first).
35	Replies that could not be sent.
36	Active nodes.

1785-KA3 DH+ Diagnostic Counters

This counter byte	Counts the number of
0	Received ACKs with a bad CRC.
1	Timeouts that expired with no ACK received.
2	Transmit retries exhausted.
3	NAKs sent due to an illegal protocol operation.
4	NAKs sent due to a bad LSAP.
5	NAKs sent due to memory available.
6	Received ACKs/NAKs that were too short.
7	Received ACKs/NAKs that were too long.
8	Times something other than an ACK/NAK received.
9	Duplicate tokens found.
10	Duplicate nodes found.
11	Token pass timeouts.
12	Token pass retries exhausted.
13	Claim token sequences entered.
14	Tokens claimed.
15	Bad CRC in received frame.
16	NAKs sent due to an illegal protocol operation.
17	NAKs sent due to a bad LSAP.
18	NAKs sent due to memory available.
19	Received frames that were too short.
20	Received frames that were too long.
21	Frame retransmissions received.
22	Received frames aborted (line noise).
23, 24	Messages successfully sent (low byte first).
25, 26	Messages successfully received (low byte first).
27, 28	Commands successfully sent (low byte first).
29, 30	Replies successfully received (low byte first).
31, 32	Commands successfully received (low byte first).
33, 34	Replies successfully sent (low byte first).
35	Replies that could not be sent (low byte first).
36	Number of active nodes.
37	Breaks sent to the IT.
38	PLC-2 resyncs.
39	T3 errors to go before force table cleared (max = 5).
40	Edit connections requested.
41	Edit connections granted.
42	Edit connections that timed out.

1785-KA5 DH+ Diagnostic Counters

This counter byte	Counts the number of ^①
0	
1	Timeouts that expired with no ACK received.
2	Transmit retries exhausted.
3	NAKs due to illegal protocol operations.
4	NAKs due to bad LSAPs.
5	NAKs due to memory available.
6	
7	
8	
9	Duplicate tokens detected.
10	Duplicate nodes detected.
11	Token pass timeouts.
12	Token pass retries exhausted.
13	Claim token sequences entered.
14	Tokens claimed.
15	Bad CRC in received frame.
16	
17	
18	NAK due to no memory sent.
19	
20	
21	Frame transmissions received.
22	Receive frames aborted (noise).
23, 24	Messages successfully sent (low byte first).
25, 26	Messages successfully received (low byte first).
27, 28	
29, 30	
31, 32	
33, 34	
35	
36	Number of active nodes.

^① A shaded cell means the counter is present but not functional.

1785-KA5 DH485 Diagnostic Counters

This counter byte	Counts the number of
0, 1	Total packets received (low byte first).
2, 3	Total messages sent (low byte first).
4	Messages ACK, timeout count.
5	Message retried, failure count.
6	NAK NO MEM sent.
7	NAK NO MEM received.
8	Bad messages received.
9	Reserved.

1785-L11B, -L20B, -L30B, -L40B, -L60B, and -L80B DH+ Channel Diagnostic Counters

This counter byte	Counts the number of
0, 1	Messages received.
2, 3	Messages sent.
4, 5	Messages received with errors.
6, 7	Messages sent with errors.
8, 9	Messages unable to receive.
10, 11	Times the network died.
12, 13	Claims won.
14, 15	Claims lost.
16, 17	New successors.
18, 19	Tokens retried.
20, 21	Tokens failed.
22, 23	Times linear scan started.
24, 25	Times linear scan failed.
26, 27	Duplicate nodes.
28, 29	Dropped tokens.
30, 31	Received SDAs.
32, 33	Received bad packets.
34, 35	Received SDA retransmissions.
36, 37	Received SDAs, but full.
38, 39	Received SDAs, SAP off.
40, 41	Transmitted SDA confirms.
42, 43	Transmitted SDA NAKs, miscellaneous.
44, 45	Transmitted SDA timeouts.
46, 47	Transmitted SDA but not ACKed.
48, 49	Transmitted SDX retries.
50, 51	Transmitted SDA failed.
52, 53	Transmitted SDA NAKed (full).
54, 55	Transmitted SDA NAKed, inactive SAP.
56, 57	Transmitted SDN confirmed.
58, 59	Transmitted SDN failed.
60, 61	Solicited rotations.
62, 63	SDNs received.

Below are diagnostic counters for the channel 0 serial port.
These counters vary depending on whether the port is configured for:

- point-to-point (full-duplex)
- half-duplex slave
- half-duplex master

This counter byte	Counts the number of
0, 1	General status words. Contains serial port information as defined below: <ul style="list-style-type: none"> •0 Bit 0: status of CTS (1 = asserted, 0 = deasserted) Bit 1: status of RTS (1 = asserted, 0 = deasserted) Bit 2: status of DSR (1 = asserted, 0 = deasserted) Bit 3: status of DCD (1 = asserted, 0 = deasserted) Bit 4: status of DTR (1 = asserted, 0 = deasserted) Bit 5: status of modem connection (1 = lost) Bits 6, 7: reserved •1 Bits 8-11: mode of serial port (0000 = system, 0001 = 1 user) Bits 12-14: reserved (set to 0) Bit 15: input buffer overflow (user mode only). More than 256 characters have been received before the execution of an ASCII read instruction.
2, 3	Messages sent (indicating retries).
4, 5	Messages received with proper BCC or CRC.
6, 7	Undelivered messages.
8, 9	ENQs sent. <u>For this protocol</u> <u>This is the number of</u> full-duplex ENQs sent half duplex message retries
10, 11	NAKs received.
12, 13	ENQs received.
14, 15	Bad packets received – packets received with incorrect BCC or CRC.
16, 17	NAKs sent.
18, 19	Duplicate messages received.
20, 21	Received errors (user mode only). Number of characters thrown away due to parity, overflow, and framing errors.
22, 23	Number of times DCD went low and then high – DCD recovered.
24, 25	Number of times modem connection was lost.

1785-L20E, -L40E, -L40L, -L60L, -L80E DH+ Diagnostic Counters

This counter byte	Counts the number of
0	ACK timeouts.
1	NAKs due to no memory received.
2	Claim tokens.
3	NAKs due to no memory sent.
4	CRC errors.
5	Duplicate packets.
6	Token timeouts.
7	Retries.
8, 9	Messages sent (high byte first).
10, 11	Messages received (high byte first).
12, 13	Commands generated (high byte first).
14, 15	Requests executed (high byte first).
16, 17	Replies sent (high byte first).
18	Rack 1 timeouts.
19	Rack 2 timeouts.
20	Rack 3 timeouts.
21	Rack 1 CRC errors.
22	Rack 2 CRC errors.
23	Rack 3 CRC errors.
24	Rack 1 B.T. errors.
25	Rack 2 B.T. errors.
26	Rack 3 B.T. errors.
27	Rack 1 re-tries.
28	Rack 2 re-tries.
29	Rack 3 re-tries.
30	Adapter timeouts.
31	Undeliverable replies.

5250 Cat. Nos.

Cat. Nos.	Link	Pages
5250-LP1, -LP2, -LP3, -LP4 ^① processors	DH+	9-33
^① PLC-5/250 processors		

5250-LP1, -LP2, -LP3, -LP4 DH+ Diagnostic Counters

This counter byte	Counts the number of
0, 1	Messages sent successfully.
2, 3	Messages received successfully (not counting duplicate messages).
4	Undeliverable messages (message was NAKed or retries were used up).
5	Response timeouts.
6	NAKs received.
7	Message retries as a result of CRC error, illegal length, DST not equal to this node, SRC not equal to node that message was sent to, or timeout.
8	NAKs sent due to memory available.
9	NAKs sent due to message's undefined LSAP.
10	Duplicate messages received.
11	Token pass retries.
12	Packets received that were aborted early.
13	Packets received that had a CRC error.
14	Packets received that had an illegal size (greater than 271 bytes or less than 3 bytes).
15	Duplicate tokens detected.
16	Recoveries from duplicate node condition.
17	Link dead timeouts.

Diagnostic Status Information

In chapter 8, we showed you the *diagnostic status* message packet format. When you send *diagnostic status* to a node, the node returns bytes of data. Use this chapter to interpret the data returned from the node (DH, DH+, or DH485 interface) that received the *diagnostic status*. It contains these sections:

Section	Page
1747 Cat. Nos.	10-2
1761, 1770, and 1771 Cat. Nos.	10-5
1773, 1775, and 1779 Cat. Nos.	10-11
1784 Cat. Nos.	10-15
1785 Cat. Nos.	10-16
5130 Cat. Nos.	10-23

Important: The values shown in the following tables are in hexadecimal format. (For more on the hexadecimal numbering system, refer to Chapter 11, “Data Encoding.”)

1747 Cat. Nos.

For status information from these cat. nos.	See page
1747-KE	10-2
1747-L20, -L30, -L40, -L511, -L514, -L524 (SLC 500, SLC 5/01 and SLC 5/02 processors)	10-3
1747-L532, -L542 (SLC 5/03 and SLC 5/04 processors)	10-4

1747-KE Status Bytes

Bytes	Bits	Contents	Description
1	1	Mode/Status	00 (no modes)
2	2	Type Extender	FE
3	3	Extended Interface Type	2C
4	4	Not used	00
5	0-4	Series/Revision	= 0 release 1; = 1 release 2, etc.
	5-7		= 0 series A; = 1 series B, etc.
6 - 16	all	Bulletin Number/Name (in ASCII)	1770-KF3
17 - 24	all	Product Specific Information	00

1747-L20, -L30, -L40, -L511, -L514, -L524 (SLC 500, SLC 5/01 and SLC 5/02 processors) Status Bytes

Bytes	Bits	Contents	Description
1	0-7	mode/status	00
2	0-7	type extender	EE
3	0-7	extended interface type	1F
4	0-7	extended processor type	1A = 20, 30, & 40 I/O SLC fixed controllers 18 = 1747-L511, -L514 SLC 5/01 controller 25 = 1747-L524 and SLC 5/02 controller
5	0-4	series/revision	= 0 (firmware release 1) = 1 (firmware release 2), etc.
	5-7		= 0 (series A) = 1 (series B), etc.
6 - 16	all	bulletin number/name (in ASCII)	500 - 20 = 1747-L20 (SLC 500 fixed controller) 500 - 30 = 1747-L30 (SLC 500 fixed controller) 500 - 40 = 1747-L40 (SLC 500 fixed controller) 5/01 = 1747-L511 & -L514 5/02 = 1747-L524
<i>Product-specific Information</i>			
17	all	major error word	low byte
18	all	major error word	high byte
19	0-4	processor mode status/control word	0 = download 1 = program 2 = reserved 3 = idle due to SUS instruction 4 = reserved 5 = reserved 6 = run 7 = test continuous scan 8 = test single scan 9-31 = reserved
	5		forces active
	6		forces installed
	7		communication active
	20		0
	1		startup protect fault ^①
	2		load memory module on error
	3		load memory module always ^①
	4		load memory module and run ^①
	5		major error - processor halted
	6		locked ^①
	7		first pass bit ^①
21	0-7	program ID	low byte
22	0-7		high byte
23	0-7	processor RAM size (in Kbytes)	
24	0	directory file corrupted	
	1	not used	= 0
	2-7	program owner node address	= 00 - 1F: program owner node address = 3F: no program owner

^① SLC 5/02 processors only.

1747-L532, -L541, -L542, -L543 (SLC 5/03 and SLC 5/04 processors) Status Bytes

Bytes	Bits	Contents	Description
1	0-5	mode/status	00
	6		testing edits
	7		edits in processor
2	0-7	type extender	EE
3	0-7	extended interface type	20 = DH485 on port 0 (RS-232) ^① 31 = DH+ on port 1 via domino plug ^② 34 = DF1 full-duplex protocol on port 0 36 = DF1 half-duplex protocol on port 0
4	0-7	extended processor type	49 = rack type 1747-L534 ^① 5B = rack type 1747-L534 ^②
5	0-4	series/revision	= 0 firmware release 1 = 1 firmware release 2, etc.
	5-7		= 0 series A = 1 series B, etc.
6 - 16	all	bulletin number/name (in ASCII)	5/03 = 1747-L532 5/04 = 1747-L542
<i>Product-specific Information</i>			
17	all	major error word	low byte
18	all	major error word	high byte
19	0-4	processor mode status/control word	00000 = download 00001 = remote PROG 00011 = idle due to SUS instruction 00110 = remote RUN 00111 = remote TEST; continuous scan 01000 = remote TEST; single scan 01001 = remote TEST; continuous step 10000 = download 10001 = PROG 11011 = idle due to SUS instruction 11110 = RUN
	5		forces active
	6		forces installed
	7		communication active
	20		0
1	startup protect fault		
2	load memory module on error		
3	load memory module always		
4	load memory module and run		
5	major error - processor halted		
6	locked		
7	first pass bit		
21	0-7	program ID	low byte
22	0-7		high byte
23	0-7	processor RAM size (in Kbytes)	

Bytes	Bits	Contents	Description
24	0	directory file corrupted	
	1	not used	= 0
	2-7	program owner node address	= 00-1F for nodes 0 through 31 = 3E for nodes 20 through FF = 3F: no program owner

^① SLC 5/03 processors only.

^② SLC 5/04 processors only.

1761, 1770, and 1771 Cat. Nos.

For status information from these cat. nos.	See page
1761-L16AWA, -L16BBB, -L16BWB, -L32AWA, -L32BWA, -L32BWB (MicroLogix 1000 processors)	10-6
1770-KF3	10-7
1771-KA, -KA2, -KC/KD, -KE/KF, -KG, -KGM, 1770-KF2 and 1774-KA	10-7

1761-L16AWA, -L16BBB, -L16BWB, -L32AWA, -L32BWA, -L32BWB (MicroLogix 1000 processors) Status Bytes

Bytes	Bits	Contents	Description
1	0-7	mode/status	00
2	0-7	type extender	EE
3	0-7	extended interface type	34 = DF1 full-duplex protocol on port 0 20 = DH485
4	0-7	extended processor type	58
5	0-4	series/revision	= 0 firmware release 1 = 1 firmware release 2, etc.
	5-7		= 0 series A = 1 series B, etc.
6 - 16	all	bulletin number/name (in ASCII)	
<i>Product-specific Information</i>			
17	all	major error word	low byte
18	all	major error word	high byte
19	0-4	processor mode status/control word	00000 = download 00001 = remote PROG 00011 = idle due to SUS instruction 00110 = RUN 00111 = TEST; continuous scan 01000 = TEST; single scan
	5		forces active
	6		forces installed
	7		communication active
	0		processor mode status/control word (high byte)
20	1		startup protect fault
	2		reserved
	3		reserved
	4		always run
	5		major error - processor halted
	6		locked
	7		first pass bit
21	0-7	program ID	low byte
22	0-7		high byte
23	0-7	processor RAM size (in Kbytes)	8
24	0	directory file corrupted	
	1	not used	= 0
	2-7	program owner node address	= 3F; no program owner

1770-KF3 Status Bytes

Bytes	Bits	Contents	Description
1	1	Mode/Status	00 (no modes)
2	2	Type Extender	FE
3	3	Extended Interface Type	2C
4	4	Not used	00
5	0-4	Series/Revision	= 0 release 1; = 1 release 2, etc.
	5-7		= 0 series A; = 1 series B, etc.
6 - 16	all	Bulletin Number/Name (in ASCII)	1770-KF3
17 - 24	all	Product Specific Information	00

1771-KA2, -KA, -KC/KD, -KE, -KF, -KG, -KGM, 1770-KF2 Status Bytes

Bytes	Bits	Contents	Description
1	0 - 2	Operating status of PLC processor	For the 1770-KF2, this byte is always 0. For other modules: 0 = Program load mode 1 = Test mode 2 = Run mode 3 = (not used) 4 = Remote Program load 5 = Remote test
	3		0 = normal communication; 1 = No communication with PLC processor
	4		0 = Normal; 1 = Download or upload mode
	5		0 = Normal; 1 = Format error in communication zone of PLC program
	6 - 7		always zero
2	0 - 3	Type of interface module and processor	0 = 1771-KC,-KD module 1 = 1771-KA2 or (1771-KA) module 2 = 1771-KA4 module 3 = 1771-KE,-KF or 1770-KF2 module 4 = 1771-KG module 5 = 1771-KGM module
	4 - 7		0 = PLC processor 1 = PLC-2 processor 2 = PLC-2/20 (LP1) Processor 3 = Mini-PLC-2 processor 5 = PLC-2/20 (LP2) processor 6 = PLC-2/02, 2/15,-2/16, or -2/17 processor 7 = PLC-2/30 processor F = computer
3 - 4	all	Octal address of the start of the PLC program. For the 1770-KF2, these bytes are always 0.	The ladder logic starts at the end of the data table. To find the physical end of PLC-2 memory, look for FFFF after the address in bytes 3 and 4. The FFFF must appear at a 1/2 Kbyte junction.
5 - 6	all	Memory size	Size of memory (in number of bytes) for 1774-PLC processor; zero for all other processors.
7 - 8	all	Diagnostic address	Starting byte address of diagnostic counters and timers.

Bytes	Bits	Contents	Description
9	0 - 4	Series and revision level of interface module. 1770-KF2/A identifies itself as Series "D" in byte 9, bits 5 to 7. Series B 1770-KF2	0 = Revision A 1 = Revision B, etc.
	5 - 7	identifies itself as Series E, and so on. 1771-KA identifies itself as a Series A. 1771-KA2 Series A identifies itself as a Series B, and so on.	0 = Series A 1 = Series B, etc.
10121	0-7	Settings of the option switches on the node interface module.	This byte is not used in replies by 1771-KC/KD or -KE/KF modules. For the other modules, the bits of this byte are defined as follows.
			1771-KA and 1771-KA2 modules
			1771-KA2 status information is opposite of 1771-KA, as noted.
	0 - 1		0 = 57,600 bits per second baud rate for DH link (undefined for 1771-KA2) 1 = Undefined 2 = Undefined 3 = Undefined (57,600 for 1771-KA2)
	2		0 = All other PLC-2 Family processors (PLC-2 processor for 1771-KA2) 1 = PLC-2 processor (all other PLC-2 processors for 1771-KA2)
	3		0 = Protected commands enabled (disabled for 1771-KA2) 1 = Protected commands disabled (enabled for 1771-KA2)
	4		0 = Unprotected commands enabled (disabled for 1771-KA2) 1 = Unprotected commands disabled (enabled for 1771-KA2)
	5		not used
	6		0 = Physical writes enabled (disabled for 1771-KA2) 1 = Physical writes disabled (enabled for 1771-KA2)
	7		0 = Transmission unprotected commands enabled (disabled for 1771-KA2) 1 = Transmission unprotected commands disabled (enabled for 1771-KA2)
			1771-KG Module (Series A)
	0		0 = Full-duplex protocol; 1 = Half-duplex protocol
	1		0 = Physical writes disabled; 1 = Physical writes enabled
	2		0 = Unprotected commands disabled; 1 = Unprotected commands enabled
	3		0 = Embedded responses disabled; 1 = Embedded responses enabled
	4		0 = No parity; 1 = Even parity
5 - 7	Asynchronous link baud rate 0 = 110 bps 1 = 300 bps 2 = 600 bps 3 = 1200 bps 4 = 2400 bps 5 = 4800 bps 6 = 9600 bps 7 = 19200 bps		

Bytes	Bits	Contents	Description																																																																	
			1771-KG Module (Series B)																																																																	
	1		0 = second module; 1 = first module																																																																	
	2		0 = accept physical/unprotected reads and writes disabled 1 = accept physical/unprotected reads and writes enabled																																																																	
	4, 3, 0		Binary values: <table border="1"> <thead> <tr> <th>Value</th> <th>Parity</th> <th>Error</th> <th>Embedded</th> <th>Protocol</th> </tr> <tr> <th></th> <th></th> <th>Check</th> <th>Responses</th> <th></th> </tr> </thead> <tbody> <tr> <td>000</td> <td>none</td> <td>BCC</td> <td>disabled</td> <td>full-duplex</td> </tr> <tr> <td>100</td> <td>even</td> <td>BCC</td> <td>disabled</td> <td>full-duplex</td> </tr> <tr> <td>010</td> <td>none</td> <td>BCC</td> <td>enabled</td> <td>full-duplex</td> </tr> <tr> <td>110</td> <td>even</td> <td>BCC</td> <td>enabled</td> <td>full-duplex</td> </tr> <tr> <td>001</td> <td>none</td> <td>BCC</td> <td>disabled</td> <td>half-duple</td> </tr> <tr> <td>x</td> <td></td> <td></td> <td></td> <td></td> </tr> <tr> <td>101</td> <td>even</td> <td>BCC</td> <td>disabled</td> <td>half-duple</td> </tr> <tr> <td>x</td> <td></td> <td></td> <td></td> <td></td> </tr> <tr> <td>011</td> <td>none</td> <td>CRC</td> <td>enabled</td> <td>full-duplex</td> </tr> <tr> <td>111</td> <td>none</td> <td>CRC</td> <td>disabled</td> <td>half-duple</td> </tr> <tr> <td>x</td> <td></td> <td></td> <td></td> <td></td> </tr> </tbody> </table>	Value	Parity	Error	Embedded	Protocol			Check	Responses		000	none	BCC	disabled	full-duplex	100	even	BCC	disabled	full-duplex	010	none	BCC	enabled	full-duplex	110	even	BCC	enabled	full-duplex	001	none	BCC	disabled	half-duple	x					101	even	BCC	disabled	half-duple	x					011	none	CRC	enabled	full-duplex	111	none	CRC	disabled	half-duple	x				
Value	Parity	Error	Embedded	Protocol																																																																
		Check	Responses																																																																	
000	none	BCC	disabled	full-duplex																																																																
100	even	BCC	disabled	full-duplex																																																																
010	none	BCC	enabled	full-duplex																																																																
110	even	BCC	enabled	full-duplex																																																																
001	none	BCC	disabled	half-duple																																																																
x																																																																				
101	even	BCC	disabled	half-duple																																																																
x																																																																				
011	none	CRC	enabled	full-duplex																																																																
111	none	CRC	disabled	half-duple																																																																
x																																																																				
	5 - 7		Asynchronous link baud rate: 0 = 110 bps 1 = 300 bps 2 = 600 bps 3 = 1200 bps 4 = 2400 bps 5 = 4800 bps 6 = 9600 bps 7 = 19200 bps																																																																	

Bytes	Bits	Contents	Description																				
10		Settings of the option switches on the node interface module.	1771-KGM Module																				
	1		0 = second module 1 = first module																				
	2		0 = accept physical/unprotected reads and writes disabled 1 = accept physical/unprotected reads and writes enabled																				
	4, 3, 0		Binary values: <table border="1"> <thead> <tr> <th>Value</th> <th>Parity</th> <th>Error Check</th> <th>Embedded Responses</th> <th>Protocol</th> </tr> </thead> <tbody> <tr> <td>001</td> <td>none</td> <td>BCC</td> <td>disabled</td> <td>half-duplex</td> </tr> <tr> <td>101</td> <td>even</td> <td>BCC</td> <td>disabled</td> <td>half-duplex</td> </tr> <tr> <td>011</td> <td>none</td> <td>CRC</td> <td>enabled</td> <td>half-duplex</td> </tr> </tbody> </table>	Value	Parity	Error Check	Embedded Responses	Protocol	001	none	BCC	disabled	half-duplex	101	even	BCC	disabled	half-duplex	011	none	CRC	enabled	half-duplex
	Value		Parity	Error Check	Embedded Responses	Protocol																	
	001		none	BCC	disabled	half-duplex																	
	101		even	BCC	disabled	half-duplex																	
	011		none	CRC	enabled	half-duplex																	
	5 - 7		Asynchronous link baud rate 0 = 110 bps 1 = 300 bps 2 = 600 bps 3 = 1200 bps 4 = 2400 bps 5 = 4800 bps 6 = 9600 bps 7 = 19200 bps																				
			1774-KA Module																				
0	0 = Unprotected commands enabled 1 = Unprotected commands disabled																						
1	not used																						
2	0 = Physical writes enabled 1 = Physical writes disabled																						
3	0 = Transmission of unprotected commands enabled 1 = Transmission of unprotected commands disabled																						
4	0 = DH port B is connected 1 = DH port A is connected																						
5	0 = PLC outputs held in last state 1 = PLC outputs turned off																						
6 - 7	0 = 57,600 bits per second DH baud rate 1 = undefined 2 = undefined 3 = undefined																						
		1770-KF2 Module																					
	0 - 1	0 = 57,600 bits per second Data Highway or Data Highway Plus baud rate 1 = undefined 2 = undefined 3 = undefined																					
	2	Not used																					
	3 - 7	Logical complement of the state of option switch SW-2, switches 1 through 5																					

1773, 1775, and 1779 Cat. Nos.

For status information from these cat. nos.	See page
1773-KA	10-11
1775-KA, 1775-S5, and 1775-SR5	10-13
1779-KP5	10-14

1773-KA Status Bytes

Bytes	Bits	Contents	Description
1	0	Operating status of controllers on loop	= 1 if controller #1 is active
	1		= 1 if controller #2 is active
	2		= 1 if controller #3 is active
	3		= 1 if controller #4 is active
	4		= 1 if controller #5 is active
	5		= 1 if controller #6 is active
	6		= 1 if controller #7 is active
	7		= 1 if controller #8 is active
2	0 - 3	Node interface and processor type	8 = 1773-KA, DH port 9 = 1773-KA, RS-232-C port 12 = 1775-S5,-SR5 (new revisions only)
	4 - 7		8 = PLC-4 Microtrol processor
3 - 4	0	DH port options	0 = 57,600 bits per second DH baud rate 1 = Undefined
	1		Not used
	2		0 = Privileged commands enabled 1 = Privileged commands disabled
	3		0 = Unprotected commands enabled 1 = Unprotected commands disabled
	4		0 = Protected commands enabled 1 = Protected commands disabled
	5 - 7		Not used
	8 - 15		Octal node number
5 - 6	0	RS-232-C port options	0 = Even parity; 1 = No parity
	1 - 3		Baud rate 0 = 19,200 bps 1 = 8,600 bps 2 = 4,800 bps 3 = 2,400 bps 4 = 1,200 bps 5 = 600 bps 6 = 300 bps 7 = 110 bps
	4 - 10		Not used
	11		0 = Protected commands enabled 1 = Protected commands disabled
	12		0 = Embedded responses enabled 1 = Embedded responses disabled
	13		0 = Unprotected commands enabled 1 = Unprotected commands disabled
	14		0 = Privileged commands enabled 1 = Privileged commands disabled
	15		0 = Half-duplex protocol 1 = Full-duplex protocol
7 - 8		Starting byte address of diagnostic timers and counters	

Bytes	Bits	Contents	Description
9	0 - 4	Module series and revision level	0 = Revision A 1 = Revision B, etc.
	5 - 7		0 = Series A 1 = Series B, etc.
10	all	Not used	
11 to 114		Eight, 13-byte groups of processor status data, one group for each of eight possible controllers on the loop.	<p>If a particular controller on the loop is not active or does not respond to the diagnostic status command, its 13 status bytes are all zeros. Otherwise, each group of processor status bytes contains the following:</p> <p>Byte: Contents:</p> <p>1 Program ID</p> <p>2 Processor ID</p> <p>3 Pointer to start program</p> <p>4 Pointer to end of available memory</p> <p>5 Size of I/O</p> <p>6 Processor error code</p> <p>7 Error word address (low byte)</p> <p>8 Error word address (high byte)</p> <p>9 Processor mode</p> <p>10 Pointer to END statement (low byte)</p> <p>11 Pointer to END statement (high byte)</p> <p>12 Pointer to end of used memory (low byte)</p> <p>13 Pointer to end of used memory (high byte)</p>

1775-KA, -S5 and -SR5 Status Bytes

Bytes	Bits	Contents	Description
1	0 - 1	Operating status of PLC-3 processor	0 = Program mode 1 = Test mode 2 = Run mode
	2		Not used
	3		0 = Normal 1 = Major processor fault
	4		0 = Normal 1 = Shutdown request
	5		0 = Normal 1 = Shutdown in effect
	6 - 7		Not used
2	0 - 3	Type of node interface and processor	6 = 1775-KA - Data Highway port, 1775-S5, or 1775-SR5 7 = 1775-KA - RS-232-C port 12 = 1775-S5,-SR5 (new revisions only)
	4 - 7		
3	all	Current context (stored in bits 4 to 7)	
4	all	Thumbwheel number	
5 - 6	all	Mode control word	The logical address of the mode control word is E0.0.0.8.
7 - 8	all	Starting byte address of diagnostic counters and timers	There is a separate block of diagnostic timers and counters for the DH port and the RS-232 port. The address given here is for the port that received the <i>diagnostic status</i> command.
9	0 - 4	Series and revision number of the module	0 = Revision A 1 = Revision B, etc.
	5 - 7	The 1775-S5 and 1775-SR5 (series A) appear as series C modules.	0 = Series A 1 = Series B, etc.
10	all	Not used	Not used
11 - 14	all	The physical address of the unused word of PLC-3 system memory.	The physical address corresponding to the logical address E60.0.0.0. This is the last word to read or write in an upload or download.
15 - 18	all	The total number of words in the PLC-3 system memory (both used and unused)	

1779-KP5 Status Bytes

Bytes	Bits	Contents	Description
1	all	00	Not used
2	all	Interface Type and Processor Type	EE = see expansion bytes (bytes 3 and 4)
3	all	Interface Type Expansion Byte	1A = 1779-KP5
4	all	Processor Type Expansion Byte	17 = DH+ information
5 - 6	all	00	Not used
7 - 8	all	Address of Active Node Table	byte 7 = low byte byte 8 = high byte
9 - 10	all	Diagnostic Counter Address	byte 9 = low byte byte 10 = high byte
11	0 - 4	1779-KP5 Revision and Series Level	0 = Revision A 1 = Revision B, etc.
	5 - 7		0 = Series A 1 = Series B, etc.
12	0 - 3	Option Switches	SW-5 - Data Highway Plus Baud Rate 2 = 230 Kb 4 = 115 Kb 6 = 57.6 Kb
	4 - 7		SW-4 - Transmit Route Updates 0 = Do not transmit route updates 3 = transmit route updates

1784 Cat. Nos.

For status information from these cat. nos.	See page
1784-KR	10-15
1784-KT,-KT2	10-15

1784-KR Status Bytes

Bytes	Bits	Contents	Description
1	0-7	Mode/Status	00 (no modes)
2	0-7	Type Extender	FE
3	0-7	Extended Interface Type	24
4	0-7	Not used	00
5	0-4	Series/Revision	= 0 release 1 = 1 release 2, etc.
	5-7		= 0 series A = 1 series B, etc.
6 - 16	all	Bulletin Number/Name (in ASCII)	1784-KR
17 - 24	all	Product Specific Information	00

1784-KT, -KT2 Status Bytes

Bytes	Bits	Contents	Description
1	0-7	PLC Mode	00
2	0-7	Interface Type	FE
3	0-7	Interface Type Extension	1B
4 - 6	all	Reserved	
7	0-7	Pointer to Diagnostic Counters	44 (low byte)
8	0-7		41 (high byte)
9	0-7	Revision	03
10	0-7	Option Switches	00
11 - 18	all	Unused	20

1785 Cat. Nos.

For status information from these cat. nos.	See page
1785-KA	10-16
1785-KA3	10-17
1785-KE	10-19
1785-KA5	10-17
1785-LT (PLC-5/15) and 6008-LTV (PLC-5 VME) controllers	10-20
1785-LT3 (PLC-5/12) and 1785-LT3 (PLC-5/25) controllers	10-22

1785-KA Status Bytes

Bytes	Bits	Contents	Description
1		Operating status of PLC processor	For the 1785-KA, this byte has one of these values: 0 = standby mode 1 = on-line mode
2	0 – 3 4 – 7	Type of interface module and processor:	E = Check interface module expansion byte (byte 3) E = Check processor expansion byte (byte 4)
3	all	Interface expansion byte	10 = 1785-KA
4	all	Processor expansion byte	10 = 1785-KA
5 – 6	all	The starting address of the counters on the link other than the one from which the diagnostic status command was issued.	
7 – 8	all	This is the starting address of the counters on the link from which the diagnostic status command was issued.	
9	0 – 4 5 – 7	Series and revision level of node interface module	0 = Revision A 1 = Revision B, etc. 0 = Series A 1 = Series B, etc
10	0 1 2 – 3 4 5 6 – 7	Settings of the option switches on the module.	0 = 57, 600 bits per second Data Highway baud rate 1 = Undefined 0 = 57,600 bits per second Data Highway Plus baud rate 1 = Undefined Not used 0 = No redundancy switch valve 1 = Redundancy switch valve 0 = Secondary switch valve 1 = Primary switch valve Not used
11 – 12	all	Address of the DH+ active node table	low byte first

1785-KA5 Status Bytes

DH+ Status Bytes			
Bytes	Bits	Contents	Description
0	all	mode	0
1	all	type	extended (EE)
2	all	interface type	1785-KA5 (30)
3	all	processor type	1785-KA5 (2F)
4 - 5	all	DH485 diagnostic counters address	low byte first
6 - 7	all	DH+ diagnostic counters address	low byte first
8	all	module revision, series	0:4 revision 5:7 series
9	all	options	0
10	all	DH+ active node table address	low byte first

DH485 Status Bytes			
Bytes	Bits	Contents	Description
0	all	type	extended (EE)
1	all	interface type	1785-KA5 (30)
2	all	processor type	1785-KA5 (2F)
3	all	revision, series	
4	all	11 bytes ASCII bulletin number	zero terminated
5	all	8 bytes of product-specific information	

1785-KA3 Status Bytes

Bytes	Bits	Contents	Description
1	0 - 2	Operating status of PLC-2	0 = Program load mode 1 = Test mode 2 = Run mode 3 = (not used) 4 = Remote program load 5 = Remote test
	3		0 = normal communication 1 = No communication with PLC-2
	4		0 = Normal 1 = Download or upload mode
	5		0 = Normal 1 = Format error in communication zone of PLC-2 program
	6 - 7		Always zero
2	0 - 3	Type of interface module and processor	D = 1785-KA3 module
	4 - 7		1 = PLC-2 processor 2 = PLC-2/20 (LP1) processor 3 = Mini-PLC-2 processor 5 = PLC-2/20 (LP2) processor 6 = PLC-2/15 7 = PLC-2/30 processor E = expansion byte (precedes byte 3)
expansion byte		Data only if byte 2 contains "ED"	1D = PLC-2/02 1E = PLC-2/05 1F = PLC-2/16 20 = PLC-2/17

Bytes	Bits	Contents	Description
3 - 4	all	Octal address of the start of the PLC program	
5 - 6	all		0 = not used
7 - 8	all	Starting byte address of diagnostic counters and timers.	Starting byte address of diagnostic counters and timers.
9	0 - 4	Series and revision level of interface module.	0 = Revision A 1 = Revision B, etc.
	5 - 7		0 = Series A 1 = Series B, etc.
10	0 - 1	Settings of the option switches on the node interface module	0 = Undefined 1 = Undefined 2 = Undefined 3 = not used
	2		0 = PLC-2 processor 1 = All other PLC-2 Family processors
	3		0 = Protected commands disabled 1 = Protected commands enabled
	4		0 = Unprotected commands disabled 1 = Unprotected commands enabled
	5		Not used
	6		0 = Physical writes disabled 1 = Physical writes enabled
	7		0 = Transmission unprotected commands disabled 1 = Transmission unprotected commands enabled
	11		0
1			0 = No terminal is editing over DH+ link 1 = A terminal is editing over DH+ link
2			0 = Directly connected terminal is not editing 1 = Directly connected terminal is editing
3 - 7		Not used	will be set to zeros
12	0 - 2	Indicates the number of I/O racks the PLC-2 is configured for.	
	3		0 = No I/O points are currently forced on or off. 1 = An I/O point has been forced on or off since the last time the directly connected terminal was connected. Important: This bit is set until the directly connected terminal is disconnected or returns to the "mode select" screen, even if the forces have subsequently been removed.

1785-KE Status Bytes

Bytes	Bits	Contents	Description
1	all	Operating status of PLC processor.	For the 1785-KE, this byte is always 0.
2	0 - 3	Type of interface module and processor	E = Check interface module expansion byte (byte3)
	4 - 7		F = Computer
3	all	Interface Module Expansion Byte	19 = 1785-KE
4	all		00 = not used
5 - 6	all	This is a pointer to the Active Node Table	low byte first.
7 - 8	all	This is a pointer to diagnostic counters	low byte first.
9	0 - 4	Series and revision level of the module	0 = Revision A 1 = Revision B, etc.
	5 - 7		0 = Series A 1 = Series B, etc.
10	0 - 1	Settings of the option switched on the module	0 = 57,600 bits per second Data Highway Plus baud rate
	2		DSR
	3 - 7		Option Switch Settings; bit set to 0 is ON

1785-LT (PLC-5/15) and 6008-LTV (PLC-5 VME) Status Bytes

Bytes	Bits	Contents	Description
1	0 - 2	Operating status of PLC-5 processor	0 = Program load 1 = Not used 2 = Run mode 3 = Not used 4 = Remote program load 5 = Remote test 6 = Remote run 7 = Not used
	3		0 = Normal 1 = Major processor fault
	4		0 = Normal 1 = Download mode
	5		Not used
	6		0 = Not testing edits 1 = Testing edits
	7		0 = No edits in processor 1 = edits in processor
2	0 - 3	Processor Type	B = PLC-5
	4 - 7		B = 1785-LT (PLC-5/15) C = 6008-LTV (PLC-5 VME)
3 - 6		Size of user memory	low word first, low byte first
7	0 - 4	Series and revision of the PLC-5	0 = Revision A 1 = Revision B, etc.
	5 - 7		0 = Series A 1 = Series B, etc.
8	all	Processor number on DH+ link	
9	all	I/O address	Address of the processor if it is an adapter. If it is a scanner, value is 0FDH.
10	0	I/O and communication parameters	0 = Double density
	1		1 = Adapter mode
	2		1 = Module group 4 top half
	5		1 = Adapter is half rack
	6		1 = Data Highway Plus at 115K baud
11 - 12	all	Number of data table files	low byte first
13 - 14	all	Number of program type files	low byte first
15	0	Forcing status	1 = Forces active
	4		1 = Forces are present in the tables.
16	all	Memory protect indication	non-zero means memory is protected
17	all	Bad RAM indication	non-zero means RAM is bad, must be cleared

1785-LT3 (PLC-5/12) and 1785-LT2 (PLC-5/25) Status Bytes

Bytes	Bits	Contents	Description
1	0 - 2	Operating status of PLC-5 processor	0 = Program load 1 = Not used 2 = Run mode 3 = Not used 4 = Remote program load 5 = Remote test 6 = Remote run 7 = Not used
	3		0 = Normal 1 = Major processor fault
	4		0 = Normal 1 = Download mode
	5		Not used
	6		0 = Not testing edits 1 = Testing edits
	7		0 = Not testing edits 1 = Testing edits
2	0 - 3	Processor Type	B = PLC-5
	4 - 7		E = Expansion byte
3		Processor Expansion Byte	13 = 1785-LT3 (PLC-5/12) 14 = 1785-LT2 (PLC-5/25)
4 - 7		Size of user memory	low word first, low byte first
8	0 - 4	Series and revision of the PLC-5	0 = Revision A 1 = Revision B, etc.
	5 - 7		0 = Series A 1 = Series B, etc.
9	all	Processor number on DH+ Link	
10	all	all I/O address	Address of the processor if it is an adapter. If it is a scanner, value is 0FDH.
11	0	I/O and communication parameters	0 = Double density
	1		1 = Adapter mode
	2		1 = Module group 4 top half
	5		1 = Adapter is half rack
	6		1 = Data Highway Plus at 115K baud
12 - 13	all	Number of data table files	low byte first
14 - 15	all	Number of data type files	low byte first
16	0	Forcing status	1 = Forces active
	4	1 = Forces are present in the tables.	1 = Forces are present in the tables.
17	all	Memory protect indication	non-zero means memory is protected
18	all	Bad RAM indication	non-zero means RAM is bad, must be cleared

1785-L11B, -L20B, -L20E, -L30B, -L40B, -L40E, -L40L, -L60B, -L60L Status Bytes

Bytes	Bits	Contents	Description
1	0 – 2	Operating status of PLC-5 processor	0 = Program load 1 = Not used 2 = Run mode 3 = Not used 4 = Remote program load 5 = Remote test 6 = Remote run 7 = Not used
	3		0 = Normal 1 = Major processor fault
	4		0 = Normal 1 = Download mode
	5		Not used
	6		0 = Not testing edits 1 = Testing edits
	7		0 = Not testing edits 1 = Testing edits
	2		0 – 3
4 – 7		E = Expansion byte	
3		Processor Expansion Byte	15 = 1785-L40B (PLC-5/40) 22 = 1785-LT4 (PLC-5/10) 23 = 1785-L60B (PLC-5/60) 28 = 1785-L40L (PLC-5/40) 29 = 1785-L60L (PLC-5/60) 31 = 1785-L11B (PLC-5/11) 32 = 1785-L20B (PLC-5/20) 33 = 1785-L30B (PLC-5/30) 4A = 1785-L20E (PLC-5/20E) 4B = 1785-L40E (PLC-5/40E) 55 = 1785-L80B (PLC-5/25) 59 = 1785-L80E (PLC-5/80E)
4 – 7	all	Size of user memory	low word first, low byte first
8	0 – 4	Series and revision of the PLC-5	0 = Revision A 1 = Revision B, etc.
	5 – 7		0 = Series A 1 = Series B, etc.
9	all	Processor number on DH+ Link	
10	all	all I/O address	Address of the processor if it is an adapter. If it is a scanner, value is 0FDH.
11	0	I/O and communication parameters	0 = Double density
	1		1 = Adapter mode
	2		1 = Module group 4 top half
	5		1 = Adapter is half rack
	6		1 = Data Highway Plus at 115K baud
12 – 13	all	Number of data table files	low byte first
14 – 15	all	Number of data type files	low byte first
16	0	Forcing status	1 = Forces active
	1 – 3	Sub-revision number of the PLC-5 processor	
	4	1 = Forces are present in the tables.	1 = Forces are present in the tables
17	all	Memory protect indication	non-zero means memory is protected
18	all	Bad RAM indication	non-zero means RAM is bad, must be cleared

Bytes	Bits	Contents	Description
19	all	Debug mode	= 0, OFF ≠ 0, ON
20 - 21	all	Hold point file	used if Debug mode is ON. Low byte first.
22 - 23	all	Hold point element	used if Debug mode is ON. Low byte first.
24 - 25	all	Edit time stamp seconds	Low byte first.
26 - 27	all	Edit time stamp minute	Low byte first.
28 - 29	all	Edit time stamp hour	Low byte first
30 - 31	all	Edit time stamp day	Low byte first
32 - 33	all	Edit time stamp month	Low byte first
34 - 35	all	Edit time stamp year	Low byte first
36	all	Port number this command received on	

5130 Cat. Nos.

For status information from these cat. nos.	See page
5130-RM1, -RM2 (PLC-5/250) controllers	10-23

5130-RM1,-RM2 (PLC-5/250) Status Bytes

Bytes	Bits	Contents	Description
1	0 - 2	Operating status of PLC-5/250 processor	0 = Program load 1 = Not used 2 = Run mode 3 = Not used 4 = Remote program load 5 = Remote test 6 = Remote run 7 = Not used
	3		0 = Normal 1 = Major processor fault
	4		0 = Normal 1 = Download mode
	5		0 = Normal 1 = Off-line
	6		0 = Not testing edits 1 = Testing edits
	7		0 = No edits in processor 1 = Edits in processor
	2		0 - 3
4 - 7		D0 = PLC-5/250	
3	all	ID	
4	0		Forces active if 1
	1		Backup system active if 1
	2		Partner system active if 1
	3		Edit resource allocated if 1
	4		Outputs reset if 1
	5		Memory invalid if 1
	6		SFC forces active if 1
	7		Edit resource allocated by user if 1
5	all	Processor Station Address on Link	

Bytes	Bits	Contents	Description
6 - 7	all	Program Change Sequence Count	1 word
8 - 9	all	Data Change Sequence Count	1 word
10 - 11	all	User-Defined Data Change Sequence Count	1 word

■ Reference

Data Encoding — Chapter 11

Uploading and Downloading with A-B Processors — Chapter 12

PLC Addressing — Chapter 13

Line Monitor Examples — Chapter 14

ASCII Codes — Chapter 15

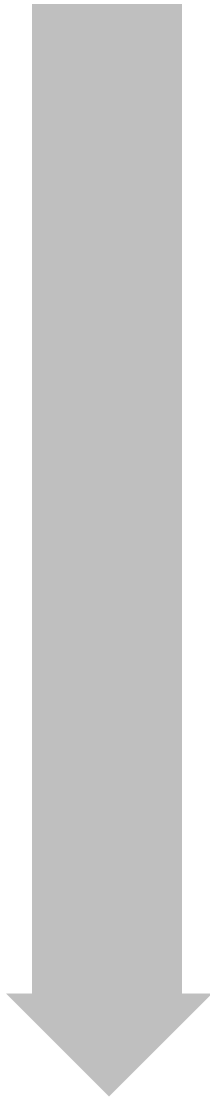

Data Encoding

This chapter provides:

- definitions of numbering systems you can use in your application
- a message packet's order of transmission

It contains these sections:

Section	Page
Numbering Systems	11-2
Order of Transmission	11-6

Numbering Systems

In general, PLC processors store binary data (1s and 0s) in 16-bit groups called **words**. If you are looking at this data from a computer, however, you may interpret it in a number of different ways, depending on your application needs. You may use any one of the following numbering systems to represent data in your computer application programs:

Numbering System	Page
decimal	11-2
binary	11-3
binary coded decimal	11-3
hexadecimal	11-4
octal	11-5
binary floating point	11-5

Important: You must design your computer application programs to make any necessary conversions from one numbering system to another. Once you have selected the numbering system that is best for your applications, use that numbering system and convert all data values to that base.

Decimal

The **decimal** numbering system is easy to use because it is most familiar. It uses the digits 0 through 9, and each digit has a place value that is a power of 10. Despite the convenience of decimal numbers, it is often easier to convert binary data to a numbering system other than decimal.

Decimal Representation, Number 239

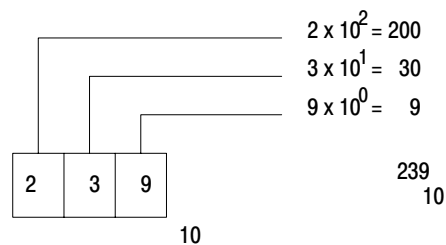

Binary

The **binary** numbering system is a simple method for computer and PLC applications because it is the most natural way to represent data bits. However, since the binary system uses the digits 0 and 1, it is cumbersome to show values in binary format.

Each digit in a binary number has a place value expressed as a power of 2. You calculate the decimal equivalent of a binary number by multiplying each binary digit by its corresponding place value and then adding the results of the multiplications.

Binary Representation, Number 239

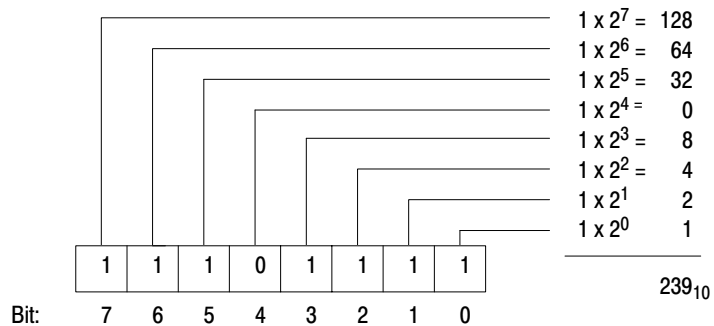

Binary Coded Decimal

PLC data is often represented in binary coded decimal (BCD) form. In this system, each group of four bits in a PLC word represents one decimal number between 0 and 9. In this way, each 16-bit word can represent a BCD value between 0 and 9,999. Many PLCs use only a three-digit BCD (12 bits). The upper digit (3 bits) is used for information such as timer or counter status.

BCD Representation of Decimal 239

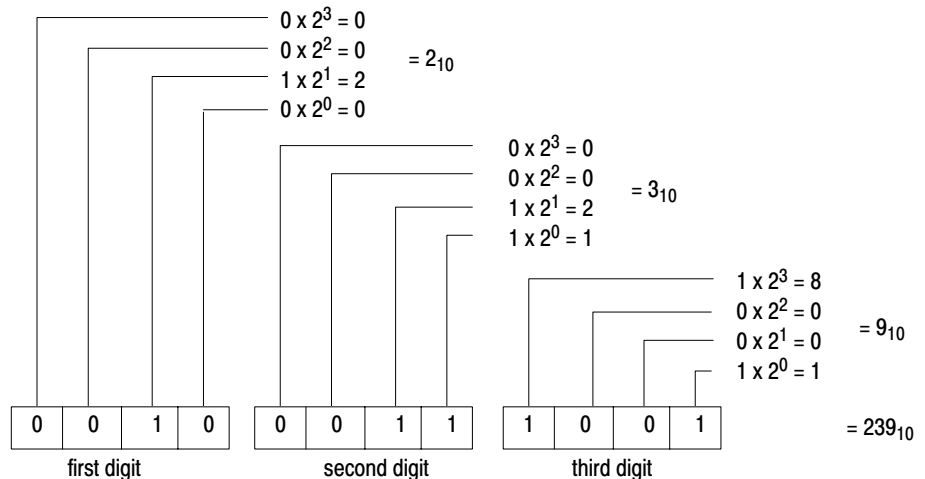

Hexadecimal

The hexadecimal (hex) numbering system is the most compact way to represent binary data and allows for the easiest conversion to and from binary. Hex uses 16 digits, numbers 0 to 9 and letters A to F. (Letters A to F are equivalent to the decimal numbers 10 to 15, respectively.)

Each group of four data bits represents one hex digit between 0 and F. Thus, each 16-bit data word can have a hex between 0 and FFFF. Each digit of a hex number has a place value that is a multiple of 16.

To convert a hexadecimal number to its decimal equivalent, multiply each hexadecimal digit by its corresponding place value and add the results of the multiplications.

Hexadecimal Representation of Decimal 423

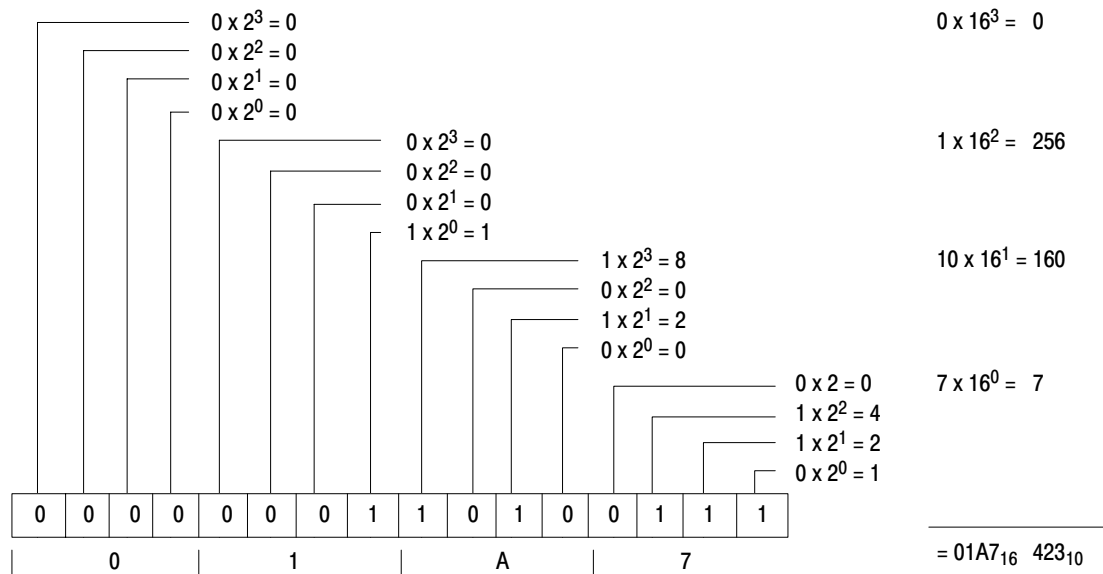

Octal

The octal number system is another easy way to represent binary data. This system uses the eight digits, 0 through 7. Each group of three data bits represents one octal digit between 0 and 7. This factor presents a slight conversion problem because bytes and words usually contain an even number of bits. Thus, an 8-bit byte can have an octal value between 0 and 377, while a 16-bit word can have an octal value between 0 and 177777.

Each digit of an octal number has a place value that is a multiple of 8. To convert from octal to decimal, multiply each octal digit by its corresponding place value and add the results of the multiplications.

Octal Representation of Decimal 239

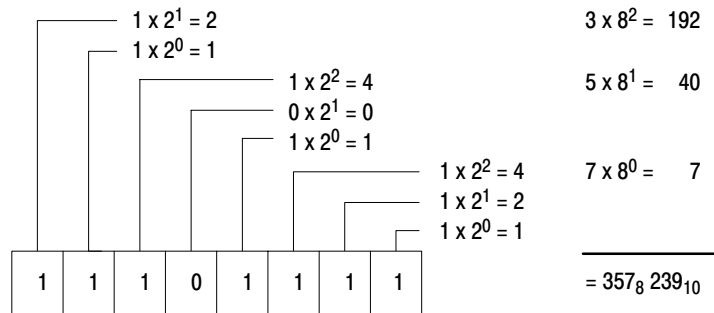

Binary Floating-point

Use the binary floating-point numbering system when you want to manipulate numbers outside of the range -32768 to $+32768$ or for a resolution finer than one unit, for example 2.075.

SLC 5/03 OS300, SLC 5/04 OS400, and PLC-5 classic processors do not support unnormalized, Not a Number (NaN), and infinity; PLC-5 enhanced processors support both NaN and infinity.

The valid range for a binary floating-point number is $\pm 3.402824 \times 10^{38}$ to $\pm 1.1754944 \times 10^{-38}$.

Order of Transmission

PLC processors store data in 16-bit (2-byte) words. The bits in these words are numbered (addressed) 0 through 17 octal, going from right to left within a word, as follows:

PLC Word																
Bits:	17	16	15	14	13	12	11	10	07	06	05	04	02	03	01	00

When a module transmits data over its asynchronous link, it transmits one byte at a time. The module always transmits the low byte (bits 00 through 07) of a word before the high byte (bits 10 through 17) of the same word. Also, the **Universal Asynchronous Receiver/Transmitter** (UART) transmits the low bit first within a byte.

First Byte								Second Byte								
Bits:	00	01	02	03	04	05	06	07	10	11	12	13	14	15	16	17

This does not present a problem at PLC nodes on the link because PLC processors store and retrieve their data in this same order of low byte first. Depending on the type of computer, however, you may have to do some extra computer application programming to maintain the proper byte and word order in PLC data stored in the computer. Three factors that can influence the ability of your computer to handle PLC data are:

- the size of words in your computer's memory
- the left-to-right or right-to-left ordering of bits within a word in your computer's memory
- whether the computer considers the low order byte of a word to have an even or an odd address

If your computer uses something other than 2-byte, 16-bit words, design your application programs to make the proper conversions from PLC word addresses to computer word addresses.

When stored in a computer, each PLC word should start on an even byte boundary. The following figures show 16-bit words in PLC and computer memory. (In all cases, the address of a word is the address of the even byte—assuming that each word is properly aligned on an even boundary.)

A 16-Bit Word in PLC Memory

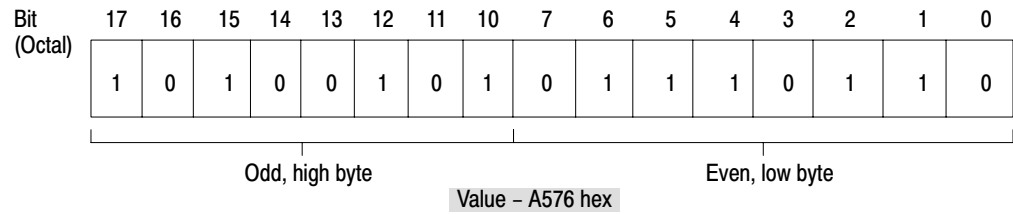

A 16-Bit Computer Word with Left-to-Right Byte and Bit Order

This figure shows a 16-bit computer word with right-to-left byte and bit order (as in DEC PDP-11/34 or VAX 11/780). It also represents a 16-bit word in an 8-bit processor (such as Zilog Z-80 or Intel 8088 microprocessor). If your computer has this type of word order, the conversion is straightforward.

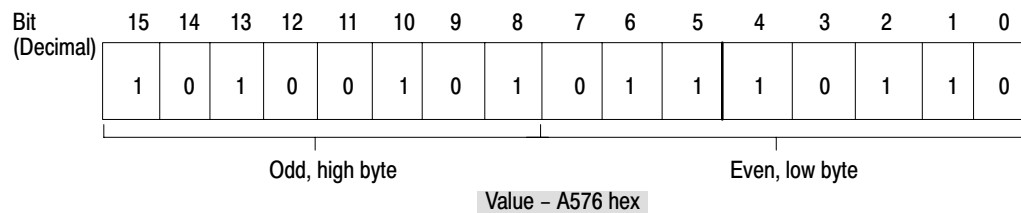

A 16-Bit Computer Word with Right-to-Left Byte and Bit Order

This figure shows a 16-bit computer word with left-to-right byte and bit order (as in IBM Series 1). If your computer has this type of word order, the conversion is more complex. You will have to swap bytes into and out of buffers.

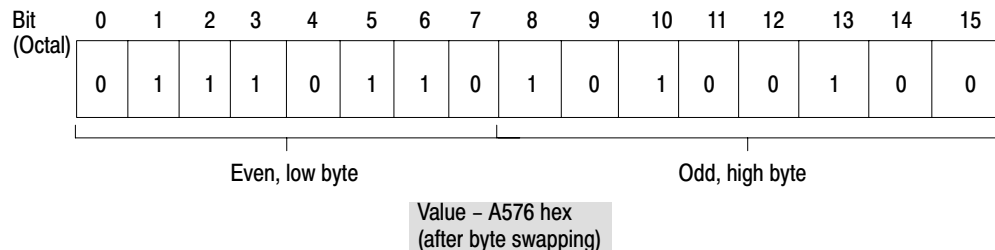

A 16-Bit Computer Word with Left-to-Right Byte Order and Right-to-Left Bit Order

This figure shows a 16-bit computer word with left-to-right byte order and right-to-left bit order (as in Zilog Z 8000 or Motorola 68000 microprocessors). If your computer has this type of word order, your communication driver must handle the task of byte swapping as it loads data into a buffer. Successive bytes received from the PLC must be stored in the following order:

1,0,3,2,5,4,7,6,9,8. . .

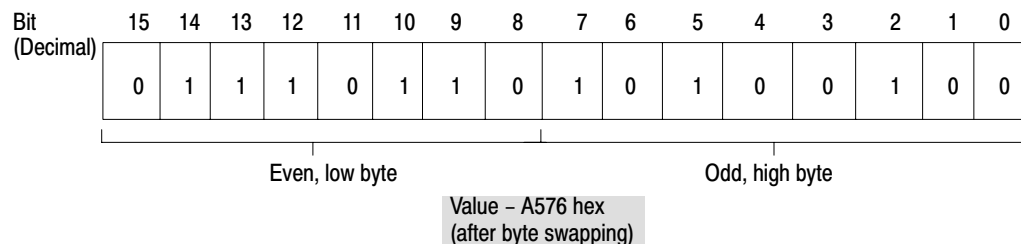

Uploading and Downloading with A-B Processors

Read this chapter to help you perform uploads from and downloads to Allen-Bradley processors. It contains these sections:

Section	Page
Uploading from the Processor	12-2
Downloading to the Processor	12-6



Upload and download constraints

When using the upload and download procedures described in this chapter, remember:

- You can download only to a processor of the same type, model, series, and revision that you upload the image from
- You cannot give the uploaded image to a programming software package
- You cannot download the 6200 Series software archive file using these procedures

If you'd like additional information on the commands used in this chapter, refer to Chapter 8, "Message Packet Status Codes (STS, EXT STS)." For more information on PLC addressing, refer to Chapter 14, "Line Monitor Examples."

Uploading from the Processor

To make sure the program image is stable during an upload, the PLC interface prohibits program changes during an upload. When you are using the following procedures, the interface blocks all access to PLC memory.

To upload information from	See page
PLC-2 processors	12-2
PLC-3 processors	12-2
PLC-5 processors	12-3
SLC 500 processors	12-6

Uploading from a PLC-2 Processor

- | 1. If you have | Then |
|---|---|
| PLC-2/05, -2/15, -2/16, -2/17, or -2/30 processor | Make sure the mode selector switch is in the RUN/PROG or PROG position. Go to step 2. |
| PLC-2/20 or Mini-PLC-2 processor | The mode selector switch can be in any position. Go to step 2. |
- To inhibit programming terminal access, enable the PLC-2 processor to receive mode-setting or physical reads using *enter upload mode*. (For more on *enter upload mode*, see page 7-10.)
 - Upload the information, using one or more *physical reads*. (For more on *physical read*, see page 7-13.)
 - To exit the upload mode, use *exit download/upload mode*. (For more on *exit download/upload mode*, see page 7-10.)

Uploading from a PLC-3 Processor

- Determine the last memory address used using *diagnostic status*. (For more on *diagnostic status*, see page 7-6.)
- Request the right to upload from the PLC-3 processor using *upload request*. (For more on *upload request*, see page 7-34.)
- Shut down the PLC-3 processor using *shutdown request*. (For more on *shutdown*, see page 7-28.)
- Upload information using one or more *physical reads*. (For more on *physical read*, see page 7-13.)
- Exit the upload mode using *restart request*. (For more on *restart request*, see page 7-23.)

Uploading from a PLC-5 Processor

Important: Uploads cannot be performed on a PLC-5 processor that is memory protected. You set or remove memory protection by using switch settings on either the I/O rack or on your PLC-5 family processor. (For more information, refer to your processor's installation manual.)

If you have this PLC-5 processor	Then
PLC-5/15/B Rev E and earlier	Follow procedure 1 on page 12-4
<ul style="list-style-type: none"> • PLC-5/10 • PLC-5/11 • PLC-5/12 • PLC-5/15/B Rev F and later • PLC-5/20 • PLC-5/20E • PLC-5/25 • PLC-5/30 	<ul style="list-style-type: none"> • PLC-5/40 • PLC-5/60L • PLC-5/40E • PLC-5/40L • PLC-5/60 • PLC-5/80 • PLC-5/80E <p data-bbox="1159 674 1455 701">Follow procedure 2 on page 12-5</p>

Procedure 1 — PLC-5/15/B processors, revision E and earlier

1. Place the PLC-5 processor in Program or Remote Program mode using *set CPU mode* or the keyswitch on the front of the processor. (For more on *set CPU mode*, see page 7-26.)
2. Place the PLC-5 processor in Upload mode using *upload all request*. This locks out all other users from accessing PLC-5 memory. (For more on *upload all request*, see page 7-33.) If a T50 is connected, it displays Download mode.

Important: Once *upload all request* is issued, the PLC-5 processor starts a 90 second timer. After 90 seconds, the processor automatically returns to the previous mode of operation. If your upload takes more than 90 seconds, you must reset the timer by sending another *upload all request* within the 90 second limit.

3. Upload the first 14 bytes of PLC-5 memory using *read bytes physical*. (For more on *read bytes physical*, see page 7-19.)
4. Upload the rest of PLC-5 memory starting at location 0A00 (hex) to 3FF0 (hex).

**Uploading PLC-5 memory**

You can accomplish a complete upload of PLC-5 memory using 107 *read bytes physical* with a size of 128 bytes plus one *read bytes physical* with a size of 112 bytes. (For more on *read bytes physical*, see page 7-19.) You can only read 112 bytes with a *physical read* sent to address 3F80.

5. Exit Upload mode using *upload completed*. (For more on *upload completed*, see page 7-34.)

Procedure 2

The processor can be in any mode while uploading.

1. Verify the processor type using *diagnostic status*. (For more on *diagnostic status*, see page 7-6.)
2. Place the processor in Upload mode using *upload all request*. (For more on *upload all request*, see page 7-33.)

This command returns a reply which contains the addresses of:

- PLC-5 memory segments that you can upload
 - memory segments that can be verified after upload
3. Upload the memory segments specified in the reply packet of *upload all request* using *read bytes physical*. (For more on *read bytes physical*, see page 7-19.)



Read bytes physical

A single segment of PLC-5 memory may require more than one *read bytes physical*. You must calculate the PLC-5 physical address for each command.

When you store PLC-5 memory information to an archive file in your computer, you must also store this information to perform the download procedure:

- physical addresses from where the memory information came
 - number of bytes uploaded from each PLC-5 physical address contained in *read bytes physical*
4. Exit Upload mode using *upload completed*. (For more on *upload completed*, see page 7-34.)
 5. Verify the upload by repeating the steps 1 and 2, but instead of writing the data to a file, compare it to the data that you previously stored in the file.
 6. Terminate the processor upload operation using *upload completed*. (For more on *upload completed*, see page 7-34.)

Uploading from an SLC 500 Processor

1. Open the directory to be read using *open file*. (For more on *open file*, see page 7-13.)
2. Read the directory using *file read*. (For more on *file read*, see page 7-10.)



File read

This may take more than one transaction.

3. Read all other processor files using *logical reads*. (For more on *logical reads*, see page 7-17.)
4. Close the program file 0, using *close file*. (For more on *close file*, see page 7-5.)

Downloading to the Processor

A download replaces the program in an SLC processor.

Important: This process may take several seconds to complete. Therefore, you must stop the PLC processor during download to prevent the PLC processor from executing a program that is changing.

The SLC processor's interface must prevent other stations from accessing the data table during download, because it may only be partially complete. The interface must also prevent a programming terminal from accessing the program during download. To help make sure that your SLC interface prevents access to the data table during download, use these download procedures.

To download information to	See page
PLC-2 processors	12-7
PLC-3 processors	12-8
PLC-5 processors	12-8
SLC 500 processors	12-10

Downloading to a PLC-2 Processor

1. Place the PLC-2 processor in Download mode by setting the mode selector switch on the PLC-2 processor to the RUN/PROG or PROG position.



ATTENTION: Leaving outputs on during a download can cause unexpected machine motion. If you are downloading to a PLC-2/20 or mini-PLC-2 processor in RUN or RUN/PROGRAM mode, the only way to turn an output off is to use *physical write* to set all output image bits to 0.

2. Place the PLC-2 processor in Download mode using *enter download mode*. (For more on *enter download mode*, see page 7-9). This command:
 - inhibits program scan
 - inhibits access by a programming terminal
 - does not allow the PLC-2 processor to send commands
 - allows the PLC-2 processor to only receive downloading and diagnostic commands
 - places a PLC-2/05, -2/15, -2/16, -2/17, or -2/30 processor in program mode. If the last state switch at each I/O chassis is set to OFF, the outputs are disabled
 - lets the outputs of a PLC-2/20 or a mini-PLC-2 remain enabled if the mode selector switch is in the Run or Run/Program position
3. If necessary, set the data table size using *set data table size*. (For more on *set data table size*, see page 7-24.)

Important: Do not write beyond your PLC-2 memory. If you need to change the size of your PLC-2 data table to download the new program, refer to your PLC-2 processor user manual.

4. Download the information using one or more *physical writes*. (For more on *physical write*, see page 7-14.)

▶ *Downloading programs*

When you download a program, write zeros into the unused portion of memory following the program.

5. Verify that the information transferred properly using *physical read*. (For more on *physical read*, see page 7-13.)
6. Exit Download mode using *exit download/upload mode* (For more on *exit download/upload mode*, see page 7-10.)

Downloading to a PLC-3 Processor

1. Determine if the destination PLC-3 processor exists using *diagnostic status*. (For more on *diagnostic status*, see page 7-6.)
2. Request the right to download to a PLC-3 processor using *download request*. (For more on *download request*, see page 7-8.)
3. Shut down the PLC-3 processor using *shutdown request*. (For more on *shutdown request*, see page 7-28.)
4. Download the information using one or more *physical writes*. (For more on *physical write*, see page 7-14.)
5. Verify that the information transferred properly using *physical read*. (For more on *physical read*, see page 7-13.)
6. Exit the download mode using *restart request*. (For more on *restart request*, see page 7-23.)

Downloading to a PLC-5 Processor

If you have this PLC-5 processor	Then
PLC-5/15/B Rev E and earlier	Follow procedure 1 on page 12-9
<ul style="list-style-type: none"> • PLC-5/10 • PLC-5/11 • PLC-5/12 • PLC-5/15/B Rev F and later • PLC-5/20 • PLC-5/20E • PLC-5/25 • PLC-5/30 	<ul style="list-style-type: none"> • PLC-5/40 • PLC-5/60L • PLC-5/40E • PLC-5/40L • PLC-5/60 • PLC-5/80 • PLC-5/80E <p>Follow procedure 2 on page 12-10</p>

Procedure 1 (PLC-5/15/B rev E and earlier)

1. Place the PLC-5 processor in Program or Remote Program mode using *set CPU mode* or the keyswitch on the front of the processor. (For more on *set CPU mode*, see page 7-26.)
2. Place the PLC-5 processor in Download mode using *download all request*. (For more on *download all request*, see page 7-8.) This command locks out all other users from accessing the PLC-5 processor.

Important: When you send a *download all request*, a 90 second timer is started. A *write bytes physical* resets this timer. If the timer times out after 90 seconds, the PLC-5 processor automatically returns to the previous mode of operation. If your download takes more than 90 seconds, reset the timer using *write bytes physical* within the 90 second limit.

3. Download the first 14 bytes of PLC-5 memory using *write bytes physical*. (For more on *write bytes physical*, see page 7-35.)
4. Download the rest of PLC-5 memory starting at location 0A00 hex to 3FF0 hex.

**Downloading PLC-5 memory**

You can download all PLC-5 memory with 107 *write bytes physical* of 128 bytes plus one *write byte physical* of 112 bytes. You can only write 112 bytes to address 3F80 hex. If you write more, an error is returned.

5. Verify that the information is transferred properly by using *read bytes physical*. (For more on *read bytes physical*, see page 7-19.)
6. Exit the download mode using *download completed*. (For more on *download completed*, see page 7-7.)

Procedure 2

1. Verify the processor type using *diagnostic status*. (For more on *diagnostic status*, see page 7-6.)
2. Place the PLC-5 processor in Program or Remote program mode using *set CPU mode* or the keyswitch on the front of the processor. (For more on *set CPU mode*, see page 7-26.)
3. Place the PLC-5 processor in Download mode using *download all request*. (For more on *download all request*, see page 7-7.)
4. Send PLC-5 memory information to the appropriate physical addresses in PLC-5 memory using *write bytes physical* with the information stored in the archive file from the upload procedure. (For more on *write bytes physical*, see page 7-35.)
5. Exit Download mode using *download complete*. (For more on *download complete*, see page 7-7.)

Downloading to an SLC 500 Processor

If you have this SLC processor	Then
SLC 500, SLC 5/01, or SLC 5/02	Follow procedure 1 on page 12-11
SLC 5/03 or SLC 5/04	Follow procedure 2 on page 12-12

Procedure 1 — SLC 500, SLC 5/01 and SLC 5/02 Processors

1. Determine the current mode of the SLC processor using *diagnostic status*, CMD 06H FNC 03H. (For more on *diagnostic status*, see page 7-6.)
2. Place the processor in Program mode using *change mode*, CMD 0FH FNC 80H. (For more on *change mode*, see page 7-5.)
3. Disable forces using *disable forces*, CMD 0FH FNC 41H. (For more on *disable forces*, see page 7-6.)
4. Get the maximum node address parameter using *read link parameters*, CMD 06H FNC 09H. (For more on *read link parameters*, see page 7-20.)
5. Initialize memory using *initialize memory*, CMD 0FH FNC 57H. (For more on *initialize memory*, see page 7-12.)
6. Put back the previous maximum node address using *set link parameters*, CMD 06H FNC 0AH. (For more on *set link parameters*, see page 7-25.)
7. Open the directory to get ownership of the processor using *open file*, CMD 0FH 81H. (For more on *open file*, see page 7-13.)
8. Write the directory length to the directory using *file write*, CMD 0FH CMD AFH. (For more on *file write*, see page 7-11.)
9. Write the program directory to program file 0 using *logical write*, CMD 0FH FNC AAH. (For more on *logical write*, see page 7-18.)
10. Write all other processor files using *logical write*, CMD FNC. (For more on *logical write*, see page 7-18.)
11. Close program file 0 using *close file*, CMD 0FH FNC 82H. (For more on *close file*, see page 7-5.)

Procedure 2 — SLC 5/03 and SLC 5/04 Processors

1. Make sure the mode selector switch is in the REM (remote) position.
2. Determine the current mode of the processor using *diagnostic status*, CMD 06H FNC 03H. (For more on *diagnostic status*, see page 7-6.)
3. Place the processor in the program mode using *change mode*, CMD 0FH FNC 80H. (For more on *change mode*, see page 7-5.)
4. Disable forces—if present—using *disable forces*, CMD 0FH FNC 41H. (For more on *disable forces*, see page 7-6.)
5. Request the download and initialize memory using:
 - A. *execute command list* CMD 0FH FNC 88H.
 - B. *logical write*, CMD 0FH FNC AAH. (For more on *logical write*, see page 7-18.)
 - C. *download*, CMD 0FH FNC 50H.
6. Secure sole access to commands using *get edit resource*, CMD 0FH FNC 11H. (For more on *get edit resource*, see page 7-11.)
7. Write the directory length to the directory using *file write*, CMD 0FH CMD AFH. (For more on *file write*, see page 7-11.)
8. Write the program directory to program file 0 using *logical write*, CMD 0FH FNC AAH. (For more on *logical write*, see page 7-18.)
9. Write all other processor files using *logical write*, CMD 0FH FNC AAH. (For more on *logical write*, see page 7-18.)
10. Complete the download using *download complete*, CMD 0FH FNC 52H. (For more on *download complete*, see page 7-7.)
11. Apply the port configuration using *apply port configuration*, CMD 0FH FNC 8FH. (For more on *apply port configuration*, see page 7-4.)
12. Release sole access to commands using *return edit resource*, CMD 0FH FNC 12H. (For more on *return edit resource*, see page 7-11.)

PLC Addressing

PLC processors support these types of addressing:

Type of Addressing	Description
logical	Type of addressing that a PLC processor uses in its ladder diagram program to access its own data table memory. This is the same type of addressing you use in non-privileged commands (that is, in commands that access only PLC data table memory).
physical	Type of addressing a computer uses to send a privileged command to a PLC node. In particular, you use physical addressing to upload or download PLC memory.
symbolic (PLC-3 only)	Used by a PLC-3 processor to represent a logical (PLC-3 only) address with ASCII characters.

This chapter explains the types of addressing a computer can use in command messages that it transmits to these processors. It contains these sections:

Section	Page
PLC-2/1774-PLC Addressing	13-2
PLC-3 Addressing	13-4
PLC-5 Addressing	13-9

PLC-2/1774-PLC Addressing

PLC-2 and 1774-PLC processors support logical and physical addressing:

For information on	See page
PLC-2/1774-PLC logical addressing	13-2
PLC-2 physical addressing	13-3
1774-PLC physical addressing	13-3

PLC-2/1774-PLC Logical Addressing

PLC-2 and 1774-PLC processors access their data tables by using an octal word address. For PLC-2/1774-PLC command messages, you must put the equivalent of this address in the 2-byte message packet field labeled ADDR. To encode a logical PLC-2/1774-PLC address:

1. Convert the octal word address to the number system you are using in your computer application program.
2. Double this converted word address to get the corresponding byte address.
3. Place the result in the ADDR field, low byte first.

For example, to address PLC-2 word 020, you must first convert the octal value 20 to the desired base. In this example, we use hexadecimal values. Octal 20 is 10 hex. Doubling this value gives us a value of 20 hex for the byte address. You then code the value 0020 hex in the ADDR field of the message, low byte first.

In binary format, ADDR looks like this:

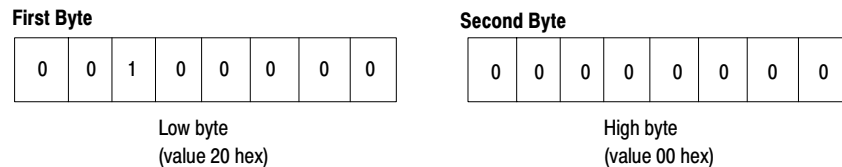

Important: 1774-PLC and PLC-2 family controllers use this same logical addressing format when they transmit command messages to another node. If you want to transmit a command message to your computer from one of these PLC processors, set up a buffer space in your computer to simulate PLC-2/1774-PLC memory. You must then write computer application programs to accept and execute commands from these nodes and to translate the ADDR value into the corresponding address in the simulated memory.

PLC-2 Physical Addressing

PLC-2 processors use physical addresses that are directly related to the logical addresses. To convert a logical address to its corresponding physical address:

1. Move bit 7 of the logical address to bit position 1.
2. Shift bits 1 through 6 to the left one position.

The following figure illustrates the conversion process for logical word address 121. Remember that the logical PLC-2 address is a byte address, so the physical address is also a byte address.

Converting a PLC-2 Logical Address to a Physical Address

PLC-2 word address = 121 octal
 logical byte address = 242 octal
 physical byte address = 0046 hex

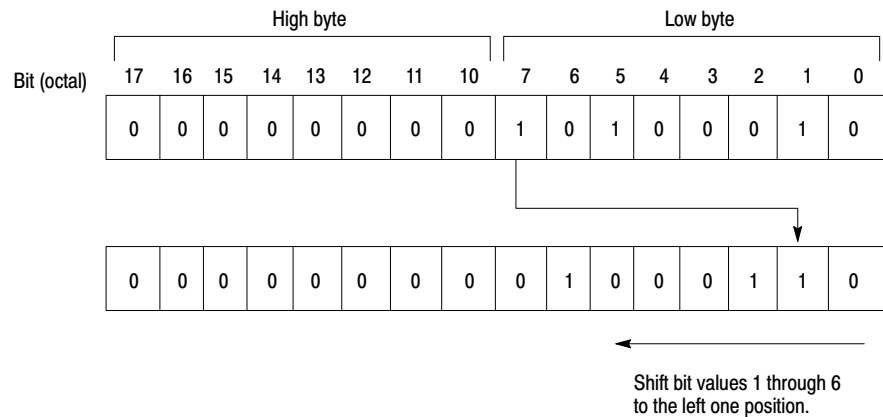

To send a *physical read* or *physical write* to a PLC-2 node, put the PLC-2 physical address in the ADDR field of the command. Be sure to encode the low byte of the physical address as the first byte in the ADDR field.

1774-PLC Physical Addressing

The 1774-PLC controllers use physical addresses that are exactly the same values as the corresponding logical addresses. Remember that the logical address is a byte address, so the physical address is also a byte address. For example, the logical byte address of the 17th word in PLC memory is 32 decimal, and the physical address is 32 decimal.

To send a physical read or write command to a 1774-PLC node, put the 1774-PLC physical address in the ADDR field of the command message packet. Be sure to encode the low byte of the physical address as the first byte in the ADDR field.

PLC-3 Addressing

PLC-3 family controllers support logical, physical, and symbolic addressing.

For information on	See page
logical addressing	13-5
physical addressing	13-7
symbolic addressing	13-8

Important: PLC-3 processors can accept and transmit PLC-2/1774-PLC command messages with the PLC-2/1774-PLC logical addressing format. Before sending a PLC-2/1774-PLC command to a PLC-3 node, you must first allocate a PLC-3 input file with the same file number as the PLC-2/1774-PLC's octal node address on the network. This file helps the PLC-3 to simulate PLC-2/1774-PLC memory. Data is read from or written to this file number.



Transmitting commands from PLC-3 processors

To transmit commands from a PLC-3 processor to your computer, set up a computer buffer to simulate a PLC-3 file and write computer application programs that are capable of interpreting all the types of addressing formats that appear in the command messages.

PLC-3 Logical Addressing

PLC-3 processors use a form of logical addressing known as **extended addressing**. With extended addressing, you specify the address for each level (or sub-division) of PLC-3 memory, down to the smallest subdivision you want to access.

You can use this method to specify up to 6 levels of extended addressing, which is enough to address any particular word in PLC-3 memory. (For more information on PLC-3 extended addressing, refer to your PLC-3 Family Programming and Operations Manual.)

To send a PLC-3 command message to a PLC-3 node, put the extended address of the node in the PLC-3 LOGICAL ADDR field. The first byte in the PLC-3 address field is a flag byte.

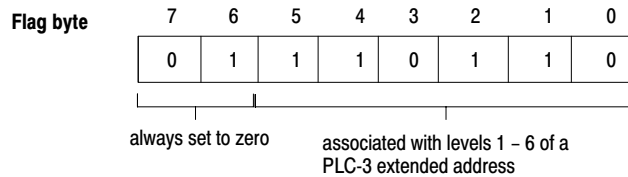

If a bit is set to 0:

<u>This address level</u>	<u>Has this default value</u>
1	3 (data table)
2	1 (current context)
all others	0

If a bit is set to 1, you must specify a value for the corresponding address level.

Important: You must specify the last level of a PLC-3 address in the address field even though it is equal to the default value.

If	Then
the address values can be specified in one byte each	you can code the values directly
it takes two bytes to specify an address	you must use a delimiter byte of value FF (hex) before each two-byte address. Any two-byte value must be encoded low byte first.

The following example shows how to enter a PLC-3 extended address in logical binary format in the address message packet field.

Example: PLC-3 logical binary addressing format

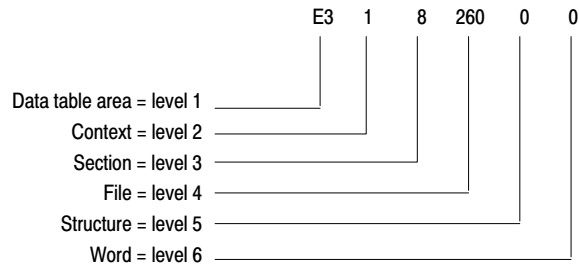

	7	6	5	4	3	2	1	0	bit	
	8	7	6	5	4	3	2	1	level	
Byte 1	0	0	1	0	1	1	0	0	flag byte: specifies that the default values are used for levels 1, 2, and 5	
Byte 2	0	0	0	0	1	0	0	0	level 3 (value = 8)	
Byte 3	1	1	1	1	1	1	1	1	level 4 delimiter: used to signal that the level 4 address uses the next two bytes	
Byte 4	0	0	0	0	0	1	0	0	level 4 (low byte)] = value 260 (decimal)
Byte 5	0	0	0	0	0	0	0	1	level 4 (high byte)	
Byte 6	0	0	0	0	0	0	0	0	level 6 (value = 0)	

Bytes	Description
1	Flag bits 0, 1, and 4 are set to 0 — default values are used for levels 1, 2, and 5 of the PLC-3 address. Flag bits 2, 3, and 5 are set to 1 — you must specify a value for levels 3, 4, and 6 in the bytes following the flag byte. (Even though the value of address level 6 is 0, the default value, the last level of a PLC-3 address is always specified in the ADDR message packet field.)
2	Address levels are specified lowest level to highest level. Address level 3 is the lowest level that must be specified, so it is specified in the first byte following the flag byte. It is followed by address level 4, then address level 6.
3, 4, and 5	The level-4 address is 260 (decimal), which is too large to fit in one byte. Therefore, byte 3 is a delimiter that contains all 1's (FF hex) and is used to delimit the 2-byte level 4 address value. The value 260 is then coded low byte first in bytes 4 and 5.
6	Specifies the level-6 address.

PLC-3 Physical Addressing

PLC-3 processors use physical addresses that are related to logical addresses by means of pointers. Since no two PLC-3 systems are configured identically, the pointers are not fixed. Therefore, there is no algorithm for converting logical to physical PLC-3 addresses.

A PLC-3 physical address goes in the 4-byte field labeled PLC-3 PHYSICAL ADDR in the PLC-3 *physical reads* or *physical writes*. (See Chapter 7, “Communication Commands.”)

A physical address is made of 24 bits. These bits are inserted in the message packet physical address field as follows. (Bits are labelled A1 to A24 respectively.)

		Function (FNC) Field							
First byte		A24	A23	A22	A21	A20	A19	A18	A17
Second byte		0	0	0	0	0	0	0	0
Third byte		A8	A7	A6	A5	A4	A3	A2	A1
Fourth byte		A16	A15	A14	A13	A12	A11	A10	A9
		Size Field							

For example, to address a command message to physical word address 12,200 decimal (002FA8 hex), you use the following binary code in the address field:

First byte	0	0	0	0	0	0	0	0	(value 00 hex)
Second byte	0	0	0	0	0	0	0	0	(always 00 hex)
Third byte	1	0	1	0	1	0	0	0	(values A8 hex)
Fourth byte	0	0	1	0	1	1	1	1	(value 2F hex)

The recommended procedure for uploading or downloading PLC-3 memory is to begin at physical address 0000 and proceed sequentially to the end of memory. Therefore, each successive *physical read* or *write* begins at the next physical address after the one where the previous command stopped. Since a single *physical read* or *write* command can transfer only about 120 words of data, it takes many such commands to upload or download the entire PLC-3 memory.

PLC-3 Symbolic Addressing

Symbolic addressing uses ASCII symbols to represent a logical address. Before using a symbolic address in a message, you must first define the symbol at the PLC-3 processor that is to receive the message. (For more information, refer to your PLC-3 user manual.)

The symbolic address field can be from 1 to 8 bytes long:

- The first byte contains the ASCII code for the first character in the symbol name
- The second byte contains the ASCII code for the second character
- and so on

If the symbol name is more than 8 characters long, encode only the first 8 characters.

This module	Accepts
1775-KA	ASCII symbols
1775-S5, -SR5	<ul style="list-style-type: none"> • ASCII symbols • logical ASCII <p>All revision levels of 1775-S5, -SR5 accept PLC-5 <i>type reads</i> and <i>type writes</i>. 1775-S5, -SR5 series A, revision E or later can also use logical ASCII with a PLC-3 <i>word range read</i> or <i>word range write</i>.</p> <p>Example of logical ASCII:</p> <pre> 00 \$N0:0 00 hex ASCI hex byte byte </pre>

To use a symbolic address in a command message, encode the symbol in the field labelled ASCII symbol in the command message formats. (See Chapter 7, "Communication Commands.")

The message formats show a byte of value zero before and after the symbolic address field. You must include these zero bytes because they act as delimiters to distinguish the symbolic address from other fields in the message

Important: Only PLC-3 controllers can transmit commands that contain symbolic addresses. If you plan to transmit this type of command message to your computer from a PLC-3 node, you must write computer application programs that are capable of accepting these commands and interpreting the symbolic addresses.

PLC-5 Addressing

PLC-5 processors support logical and physical addressing:

For information on	See page
logical addressing	13-10
physical addressing	13-16
floating point	13-17



Transmitting commands from PLC-5 processors

To transmit commands from a PLC-5 processor to your computer, set up a computer buffer to simulate a PLC-5 file and write computer application programs. The programs must be capable of interpreting all the types of addressing formats that appear in the command messages.

Important: PLC-5 processors can receive and transmit PLC-2/1774-PLC type command messages with the PLC-2/1774-PLC logical addressing format. Before sending a PLC-2/1774-PLC command to a PLC-5 node, you must first allocate a PLC-5 file with a file number that is the decimal equivalent of the PLC-2/1774-PLC's octal node number. This file helps the PLC-5 to simulate PLC-2/1774-PLC memory. Data is read from or written to this file number.

PLC-5 Logical Addressing

PLC-5 processors, like PLC-3 processors, use a form of logical addressing. With logical addressing, you specify the address for each level (or sub-division) of PLC-5 memory, down to the smallest subdivision you want to access:

With this processor	You can specify up to
PLC-5	4 levels of extended addressing, which is enough to address any word in PLC-5 memory.
PLC-5/250	7 levels of extended addressing, which is enough to address any word in PLC-5/250 memory.

To send a command message to a PLC-5 node, you put the extended address of the node in the field labelled PLC-5 SYSTEM ADDRESS in the message block formats of your program. (See Chapter 7, “Communication Commands.”) There are two types of PLC-5 logical addressing:

Logical Addressing Type	Processors	Description	Page
logical binary addressing	PLC-5	A series of bytes used to encode up to 4 levels of an address.	13-11
	PLC-5/250	A series of bytes used to encode up to 7 levels of an address.	13-13
logical ASCII addressing	PLC-5 and PLC-5/250	User-specified address in the same form that you use at the programming node. This addressing lets any device communicate with any other device, without knowing the internal memory structure of the target device.	13-15

PLC-5 Logical Binary Addressing

Byte	Contents
1	<p>the mask byte</p> <p>This byte determines which four levels of the address are specified. The mask is read from the LSB to the MSB. If a level of an address is not specified, it uses the default value, which is always 0, except for the file number which has a default of 1.</p> <p>You must always specify the last level of an address (even if it is a 0) so that the actual number of levels in a particular address can be determined.</p> <p>A 1 in the mask bit corresponding to a particular address level signifies that that particular address level is encoded in the bytes which follow. Only those address levels with a 1 in the corresponding mask bit are encoded.</p> <p>For example:</p> <ul style="list-style-type: none"> • 00001111 means that there are 4 levels in the address and all 4 levels are encoded • 00000101 means there are 3 levels in the address and level 2 uses the default value (the default is always 0 for level 2). Only levels 1 and 3 are encoded. <p>This byte is required.</p>
2	the first level of the address not using the default value
...N	up to 4 levels of addressing

Important: If the value of the mask or a level of the address is greater than or equal to 255, you cannot encode it into 1 byte. You must flag this case by programming an FF hex at the level address to signify that the level address is greater than or equal to 255 and the next 2 bytes will contain the level address. Then, code the level into the following two bytes. After 255 (FF hex), you send the bytes with low byte first, high byte second.

The following figures show examples of PLC-5 logical binary addresses.

PLC-5 Logical Binary Address to Access the Address N7:30

Byte		
1	0 0 0 0 0 1 1 1	mask byte: indicates 3 levels of addressing will be encoded.
2	0 0 0 0 0 0 0 0	level 1 (value = 0); data table
3	0 0 0 0 0 1 1 1	level 2 (value = 7); file
4	0 0 0 1 1 1 1 0	level 3 (value = 30); element or word

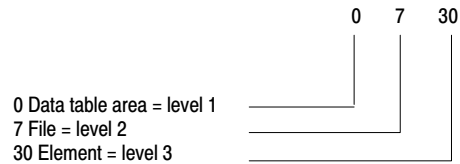

PLC-5 Logical Binary Address to Access the Address B3:300

Byte		
1	0 0 0 0 0 1 1 0	mask byte: indicates 3 levels in the address. Level 1 uses the default (0). Therefore, only levels 2 and 3 will be encoded.
2	0 0 0 0 0 0 1 1	level 2 (value = 3); file
3	1 1 1 1 1 1 1 1	FF flag indicating the next level is too large (300) to encode in one byte so it will be encoded into the next 2 bytes.
4	0 0 1 0 1 1 0 0	level 3, low byte (value = 44); element or word
5	0 0 0 0 0 0 0 1	level 3, high byte (value = 256); element or word

PLC-5 Logical Binary Address to Access the Address T4:2.ACC

Byte		
1	0 0 0 0 1 1 1 1	mask byte: indicates 4 levels of addressing to encode.
2	0 0 0 0 0 0 0 0	level 1 (value = 0); data table
3	0 0 0 0 0 1 0 0	level 2 (value = 4); section
4	0 0 0 0 0 0 1 0	level 3 (value = 2); element or word
5	0 0 0 0 0 0 1 0	level 4 (value = 2); sub-element ^①

^① Sub-element: 00 = control, 01 = preset, 02 = accumulative.

PLC-5 Logical Binary Address to Access the Address PD12:10.SP

Byte		
1	0 0 0 0 1 1 1 1	mask byte: indicates 4 levels of addressing to encode.
2	0 0 0 0 0 0 0 0	level 1 (value = 0); data table
3	0 0 0 0 1 1 0 0	level 2 (value = 12); section
4	0 0 0 0 1 0 1 0	level 3 (value = 10); element or word
5	0 0 0 0 0 0 1 0	level 4 (value = 2); sub-element ^①

^① Sub-element: 00 = control, 0 = preset, 02 = accumulative.

PLC-5 Memory (for use with figures on page 13-12)

level 1	level 2	level 3	level 4
0 (data table)	file number	element number	sub-element number
		Default files 0 - 999	timer/counter control
		0 output	0 control
		1 input	1 preset
		2 status	2 accumulated
		3 binary	2 position
		4 timer	
		5 counter	PD ^①
		6 control	0, 1 control
		7 integer	2 SP
		8 float	4 Kp
			6 Ki
			8 Kd
		9 - 999 user config	26 PV
			5 rack/grp/slot
			BT
			0 control
			1 RLEN
			2 DLEN
			3 data file #
			4 element #
			5 rack/grp/slot
			MG
			0 control
			1 error
			2 RLEN
			3 DLEN

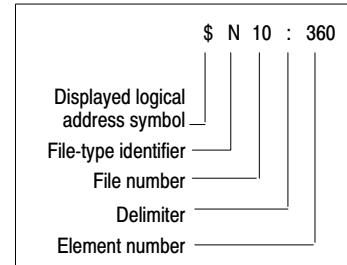

^① All PD values are floating point values, so they are two words long.

PLC-5/250 Logical Binary Addressing

Byte	Contents										
1	<p>mask byte</p> <p>The LSB determines whether the module ID byte is specified or use the default value, which is always 0; bits 1 through 7 are associated with levels one through seven of a PLC-5/250 extended address.</p> <p>You must always specify the last level of an address (even if it is a 0) so that the actual number of levels in a particular address can be determined.</p> <p>If a bit is set to 0, then a default value is assumed for the corresponding address level. If a bit is set to 1, then you must specify a value for the corresponding address level in the bytes which follow. Only those address levels and the module ID byte with a 1 in the corresponding mask bit are encoded. For example:</p> <ul style="list-style-type: none"> •01111111 means that the module ID byte and 7 levels are specified. •00111010 means the module ID byte uses the default value. There are 7 levels in the address, and level 2 uses the default value (the default is always 0). <p>This byte is required.</p>										
2	<p>the module ID byte if there is a 1 in the LSB of the mask byte; otherwise, it contains the first level of the address not using the default value</p> <table border="0"> <tr> <td><u>Memory Type</u></td> <td><u>Module ID Byte Value</u></td> </tr> <tr> <td>System memory (RM)</td> <td>0</td> </tr> <tr> <td>Module memory (LP)</td> <td>(class x 10) + pushwheel number</td> </tr> <tr> <td>where LP class = 3</td> <td></td> </tr> <tr> <td>I/O memory (RS)</td> <td>1</td> </tr> </table> <p>This byte is required.</p>	<u>Memory Type</u>	<u>Module ID Byte Value</u>	System memory (RM)	0	Module memory (LP)	(class x 10) + pushwheel number	where LP class = 3		I/O memory (RS)	1
<u>Memory Type</u>	<u>Module ID Byte Value</u>										
System memory (RM)	0										
Module memory (LP)	(class x 10) + pushwheel number										
where LP class = 3											
I/O memory (RS)	1										
3	<p>the first level of the address not using the default value if the module ID byte is encoded. Otherwise, it contains the second level of the address not using the default value.</p>										
4	<p>the next level of the address not using the default value.</p>										
n	<p>up to 7 possible levels of addressing.</p>										

Important: If the value of the mask or a level of the address is greater than or equal to 255, then you cannot encode it into 1 byte. You must flag this case by programming an FF hex at the level address to signify that the level address is greater than or equal to 255 and the next 2 bytes contain the level address. Then code the level into the following two bytes.

The following figures show examples of PLC-5/250 logical binary addresses.

PLC-5/250 Logical Binary Address to access the LP address 1N5:300

Byte		mask byte: indicates the module ID byte and 5 levels of addressing will be encoded.
1	0 0 1 1 1 1 1 1	
2	0 0 0 1 1 1 1 1	module ID byte (LP) = (class x 10) + pushwheel (value = 31)
3	0 0 0 0 0 0 1 0	level 1 (value = 2)
4	0 0 0 0 0 0 0 0	level 2 (value = 0)
5	0 0 0 0 0 0 0 1	level 3 (value = 1)
6	0 0 0 0 0 1 0 1	level 4 (value = 5)
7	1 1 1 1 1 1 1 1	level 5 flag (value = FF hex)
8	0 0 1 0 1 1 0 0	(44 - lower byte of word)
9	0 0 0 0 0 0 0 1	(256 - upper byte of word)

Byte 8 + Byte 9 = 300

PLC-5 Logical Binary Address to access the RS address I:007

Byte		
1	0 0 0 0 0 1 1 1	mask byte; indicates 3 levels in the address
2	0 0 0 0 0 0 0 1	level 1 (value = 1)
3	0 0 0 0 0 0 0 1	level 2 (value = 1)
4	0 0 0 0 0 1 1 1	level 3 (value = 7)

PLC-5/250 Logical Binary Address to access the LP address 2F0:0

Byte		mask byte; indicates the module ID byte will be encoded and there are 5 levels in the address. Levels 2 and 4 use the default (0). Therefore, only levels 1,3, and 5 will be encoded. Even though level 5 is a 0, it must be encoded, because it is the last level in the address.
1	0 0 1 0 1 0 1 1	
2	0 0 1 0 0 0 0 0	module ID byte (LP) = (class x 10) + pushwheel (value = 32)
3	0 0 0 0 0 0 1 0	level 1 (value = 2)
4	0 0 0 0 0 1 0 0	level 3 (value = 4)
5	0 0 0 0 0 0 0 1	level 5 (value = 0, the default, but must be encoded because it is the last level)

PLC-5/250 RM/LP Memory (for use with figures on page 13-14)

level 1	level 2	level 3	level 4	level 5	level 6	level 7
1 public stat	word					
2 data	0 system	sect	file	element	member	submember
		0 binary				
		1 integer				
		2 long integer				
		3 reserved				
		4 float				
		5 timer			0 EN	
					1 TT	
					2 DN	
					3 PRE	
					4 ACC	
		6 counter			0 CU	
					1 CD	
					2 DN	
					3 OV	
					4 UN	
					5 PRE	
					6 ACC	
		7 control				
		8 PID				
		9 message				
		10 string				

Logical ASCII Addressing

Logical ASCII addressing is supported by PLC-5/250, PLC-5, and PLC-3 processors. Logical ASCII addressing allows you to specify an address in the same form that you use at the programming node, and lets any device communicate with any other device—without knowing the internal memory structure of the target device.

A logical ASCII address starts with an ASCII NULL (0) character and a dollar sign (\$) to differentiate it from symbolic addressing. The rest of the address then follows, as a string of ASCII characters. The string is terminated with another NULL character.

Logical ASCII address that accesses the 360th element in file 10

Byte	ASCII	HEX	Contents
1	NUL	0 0	A null character that tells the PLC-5 processor that an ASCII address is to follow.
2	\$	2 4	An ASCII "\$" that differentiates a logical ASCII address from a symbolic address.
3	N	4 E	A hex value that corresponds to one character in the PLC-5 ASCII address N10:360. Each byte contains a hex value. For example, byte 3 contains the value for the ASCII character (4 E). Refer to Chapter 15, "ASCII Codes," for a list of ASCII characters and their hex, binary, and decimal values.
4	1	3 1	
5	0	3 0	
6	:	3 A	
7	3	3 3	
8	6	3 6	
9	0	3 0	
10	NUL	0 0	A null character that ends the ASCII address specification.

PLC-5 Physical Addressing

PLC-5 processors use physical addresses that are related to logical addresses by means of pointers. Since no two PLC-5 systems are configured identically, the pointers are not fixed. Therefore, there is no algorithm for converting logical to physical PLC-5 addresses.

A PLC-5 physical address goes in the 4-byte field labelled PLC-5 PHYSICAL ADDR in the PLC-5 *physical read* or *write* command message packets. A physical address is made of 24 bits. These bits are inserted in the message packet physical address field as follows (bits are labelled A1 to A24 respectively):

		Function (FNC) Field							
First byte		A8	A7	A6	A5	A4	A3	A2	A1
Second byte		A16	A15	A14	A13	A12	A11	A10	A9
Third byte		A24	A23	A22	A21	A20	A19	A18	A17
Fourth byte		0	0	0	0	0	0	0	0
		Size Field							

For example, to address a command message to physical word address 12,200 decimal (002FA8 hex), use the following binary code in the address field:

First byte	1	0	1	0	1	0	0	0	(value A8 hex)
Second byte	0	0	1	0	1	1	1	1	(value 2F hex)
Third byte	0	0	0	0	0	0	0	0	(values 00 hex)
Fourth byte	0	0	0	0	0	0	0	0	(always 00 hex)

The recommended procedure for uploading or downloading PLC-5 memory is to begin at physical address 0000 and proceed sequentially to the end of memory. Therefore, each successive *physical read* or *write* begins at the next physical address after the one where the previous command stopped. Since a single *physical read* or *write* command can transfer only about 120 words of data, it takes many commands to upload or download the entire PLC-5 memory.

PLC-5 Floating Point

PLC-5 *type reads* and *type writes* use the IEEE floating point. (This is the default for PLC-5 processors.) This means data is returned:

- low word then high word
- low byte then high byte

Example: PLC-5 *type read*

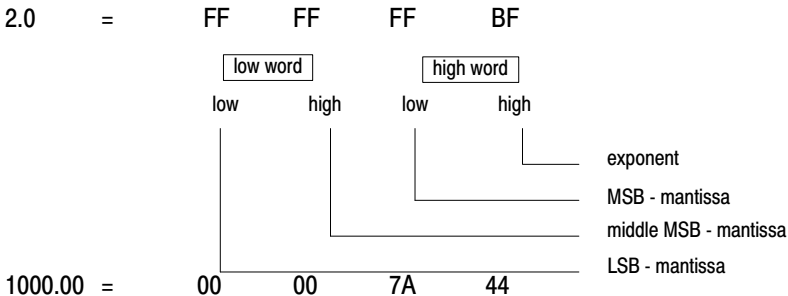

Example: PLC-5 *word range read*

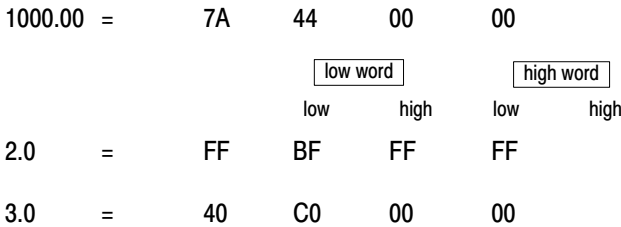

Line Monitor Examples

This chapter contains line monitor examples for DF1 protocol. Each example shows how actual commands and replies look on a line monitor (bytes are shown in hexadecimal). It contains these sections:

Section	Page
Half-duplex Line Monitor Example	14-2
Full-duplex PLC-2 Line Monitor Example	14-3
Full-duplex PLC-3 Line Monitor Example	14-6

Half-duplex Line Monitor Example

When monitoring half-duplex protocol in two-wire mode, you need to monitor only one line. The example below shows a message sent by the master and a reply sent by the slave in response to a poll. Slave responses are in boldface:

Message from master to slave and slave acknowledgement:

DLE SOH stn DLE STX message DLE ETX CRC **DLE ACK**

Message sent from slave to master in response to poll and slave acknowledgement:

DLE ENQ stn **BCC DLE STX message DLE ETX CRC DLE ACK**

Poll with a DLE EOT in response:

DLE ENQ stn **BCC DLE EOT**

Use the following CRC example to verify your CRC routine:

master:	DLE	SOH	STN	DLE	STX	DST	SRC	CMD	STS	TNS	ADDR	SIZE	DLE	ETX	CRC
	10	01	11	10	02	11	07	01	00	4100	1200	0C	10	03	CF 40
slave:	DLE	ACK													
	10	06													
master:	DLE	ENQ	STN	BCC											
	10	05	11	EF											
slave:	DLE	STX	DST	SRC	CMD	STS	TNS	DATA					DLE	ETX	CRC
	10	02	07	11	41	00	4100	00 00 00 00 00 00 00 00 00 00 00 00 00 00 00 00	10	03	CF 40				
master:	DLE	ACK	DLE	ENQ	STN	BCC									
	10	06	10	05	11	EF									
slave:	DLE	EOT													
	10	04													

Full-duplex PLC-2 Line Monitor Example

In the following example an *unprotected read* (CMD 01 hex) is sent:

- from a computer connected to a 1770-KF2 with Data Highway node address 012 (octal)
- to the PLC-2/30 connected to a 1771-KA2 with Data Highway node address 011 (octal)

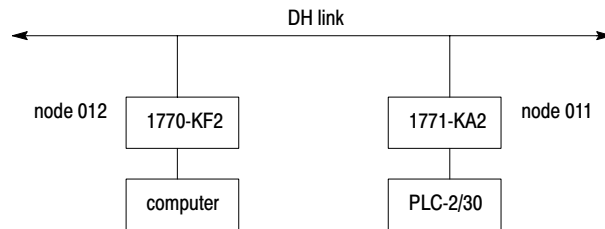

Command

Path 1	DLE	STX	DST	SRC	CMD	STS	TNS		ADDR		SIZE	DLE	ETX	BCC		
	10	02	09	00	01	00	01	00	11	00	02	10	03	E2		
Path 2															DLE	ACK
															10	06

Reply (sometime later)

Path 1	DLE	STX	DST	SRC	CMD	STS	TNS		DATA		DLE	ETX	BCC			
	10	02	0A	09	41	00	01	00	FF	FF	10	03	AD			
Path 2															DLE	ACK
															10	06

Command		
Field	Value	Function
DLE STX (2 bytes)	10 02	Indicates the start of a message
DST (destination)	09	Indicates the remote node address that the computer is communicating to. 09 hex equals 011 octal, the address of the 1771-KA2.
SRC (source)	00	Indicates the Data Highway node address that is the source of the message. In this example, the computer uses an SRC byte of 00 (hex). The asynchronous interface (1770-KF2) automatically inserts the correct SRC value before sending the message across Data Highway to the 1771-KA2.
CMD (command)	01	Indicates the specific type of command. In this example, the CMD byte has the value 01 (hex) which indicates an <i>unprotected read</i> of the PLC-2/30 data table.
STS	00	Indicates the status of the message. A command message should always set this field to 00 (hex).
TNS (transaction) (2 bytes)	01 00	Indicates a specific transaction value for each message. The TNS value increments for each message packet. This value makes each message uniquely different, which helps you check for duplicate message packets.
ADDR (address) (2 bytes)	11 00	Specifies the PLC-2 data table address where the <i>unprotected read</i> starts. The combination of these two bytes points to a byte address. Since the PLC-2 works in word (2 byte) increments, the address should specify an even number of bytes. The address must be transferred low byte first. In our example, the address 11 00 (hex, low byte first) equals 000 022 octal byte address or 000 011 octal word address.
SIZE	02	Specifies how many bytes of PLC-2 data table information you read in this transaction.
DLE ETX (2 bytes)	10 03	Indicates the termination of the message.
BCC (block check character)	E2	Used to check the accuracy of the message transmission. You can optionally use CRC bytes here. The BCC value must equal the 2's compliment of the 8-bit sum of all data bytes between DLE STX and DLE ETX. (For more information on BCC and CRC error checking, see page 5-4 .)
DLE ACK	10 06	Sent from the module (1770-KF2) back to the computer to indicate that the module successfully received the message. If the BCC value calculated by the module does not match the BCC value in the message packet, the module sends a DLE NAK (10 15) instead of the DLE ACK (hex).

Reply		
Field	Value	Function
DLE STX (2 bytes)	10 02	Indicates the start of the reply message
DST (destination)	0A	Indicates the node address that the reply is being sent back to. In our example command message, the 1770-KF2 put its address in the source (SRC) byte before sending the command message to the 1771-KA2. The 1771-KA2 takes the source byte from the command message and makes it the destination byte of the reply message. In our example, the reply message is sent back to the 1770-KF2, node address 012 octal (0A hex).
SRC (source)	09	Indicates the Data Highway node address that is the source of the message. In this example, the reply is being sent from the 1771-KA2 at node address 011 octal (09 hex).
CMD (command)	41	Indicates the specific type of command. In a reply packet, 40 hex is added to the CMD byte to indicate that the packet is a reply. In this example, the CMD byte in the command message was 01 hex (<i>unprotected read</i>), so the CMD byte in the reply message is 41 hex.
STS (status)	00	Indicates the status of the message. If there is a problem with the message or the network, a status code appears in this byte. In our example, the message is successful (status code 00 hex). (For a list of status codes, see Chapter 8, "Message Packet Status Codes (STS, EXT STS).")
TNS (transaction) (2 bytes)	01 00	Indicates a specific transaction value for each message. The TNS value for the reply message is the same as the TNS value for the command message. This allows the computer to keep track of commands and their associated replies.
DATA	FF FF	In our example, the computer reads two actual bytes of data from the PLC-2/30 data table (octal word 011). These bytes of data are FF FF hex (1111 1111 1111 1111 binary). This indicates that all 16 bits at octal word 011 are set on.
DLE ETX (2 bytes)	10 03	Indicates the termination of the reply message.
BCC (block check character)	AD	Used to check the accuracy of the message transmission. You can optionally use CRC bytes here. The BCC value must equal the 2's compliment of the 8-bit sum of all data bytes between DLE STX and DLE ETX. (For more information on BCC and CRC error checking, see page 5-4.)
DLE ACK	10 06	Sent from the computer back to the module (1770-KF2) to indicate that the computer successfully received the message. If the BCC value calculated by the module does not match the BCC value in the message packet, the module sends a DLE NAK (10 15 hex) instead of the DLE ACK (hex). If the module does not receive a DLE ACK or DLE NAK from the computer within approximately one second (1771-KE, -KF, -KG only), it sends a DLE ENQ to see if re-transmission is necessary.

Full-duplex PLC-3 Line Monitor Example

In this example three *word range reads* (CMD 0F, FNC 01) are sent:

- from a computer connected to a 1770-KF2 with DH node address 012 (octal)
- to the PLC-3 connected to a 1775-KA with DH node address 011 (octal)

This example requires three commands and the corresponding replies to read 684 bytes of data from the PLC-3 processor. The following describes the first command and reply fields only. The fields of the second and third commands and their replies are the same except for the TNS, PACKET OFFSET, and BCC fields:

Command #1:

	DLE	STX	DST	SRC	CMD	STS	TNS	FNC	PACKET OFFSET	TOTAL TRANS	ADDRESS	SIZE	DLE	ETX	BCC		
Path 1	10	02	09	00	0F	00	02 00	01	00 00	56 01	2C 08 0A 00	E4	10	03	6C		
																DLE	ACK
Path 2																10	06

Reply #1 (sometime later)

	DLE	STX	DST	SRC	CMD	STS	TNS		DATA FROM PLC-3		DLE	ETX	BCC				
Path 1	10	02	0A	09	4F	00	02 00		<<228 bytes of data>>		10	03	9C				
																DLE	ACK
Path 2																10	06

Command #2

	DLE	STX	DST	SRC	CMD	STS	TNS	FNC	PACKET OFFSET	TOTAL TRANS	ADDRESS	SIZE	DLE	ETX	BCC		
Path 1	10	02	09	00	0F	00	03 00	01	72 00	56 01	2C 08 0A 00	E4	10	03	F9		
																DLE	ACK
Path 2																10	06

Reply #2 (sometime later)

	DLE	STX	DST	SRC	CMD	STS	TNS		DATA FROM PLC-3		DLE	ETX	BCC				
Path 1	10	02	0A	09	4F	00	03 00		<<228 bytes of data>>		10	03	9B				
																DLE	ACK
Path 2																10	06

Command #3

	DLE	STX	DST	SRC	CMD	STS	TNS	FNC	PACKET OFFSET	TOTAL TRANS	ADDRESS	SIZE	DLE	ETX	BCC		
Path 1	10	02	09	00	0F	00	04 00	01	E4 00	56 01	2C 08 0A 00	E4	10	03	86		
																DLE	ACK
Path 2																10	06

Reply #3 (sometime later)

	DLE	STX	DST	SRC	CMD	STS	TNS		DATA FROM PLC-3		DLE	ETX	BCC				
Path 1	10	02	0A	09	4F	00	04 00		<<228 bytes of data>>		10	03	9A				
																DLE	ACK
Path 2																10	06

Command		
Field	Value	Function
DLE STX (2 bytes)	10 02	Indicates the start of a message
DST (destination)	09	Indicates the remote node address that the computer is communicating to. 09 hex equals 011 octal, the address of the 1771-KA2.
SRC (source)	00	Indicates the DH node address that is the source of the message. In this example, the computer uses an SRC byte of 00 (hex). The asynchronous interface (1770-KF2) automatically inserts the correct SRC value before sending the message across the DH link to the 1775-KA.
CMD (command)	0F	Indicates the type of command. In this example, the CMD byte has the value 0F (hex) which points to a group of PLC-3 commands. The FNC byte specifies which command in the group is sent.
STS	00	Indicates the status of the message. A command message should always set this field to 00 (hex).
TNS (transaction) (2 bytes)	02 00	Indicates a specific transaction value for each message. The TNS value increments for each message packet. This value makes each message uniquely different, which helps you check for duplicate message packets. In this example, there are three commands, and each must have a different TNS value.
FNC (function)	01	Used with the CMD byte, this byte determines which command is sent. The CMD byte specifies a group of commands, and the FNC byte specifies a command within that group of commands. In this example, the FNC byte specifies command 01 of command group 0F. (This is the <i>word range read</i> command.)
PACKET OFFSET (2 bytes)	00 00	Contains the offset from the address in the address field. In this example, the computer sends three commands for one transaction. Each command reads 114 words. The first command starts at the address in the ADDR field with no offset. The second command has an offset of 72 00 (00 72 hex = 114 decimal). This means that the second command begins reading after the 114 words that were read by the first command. Likewise, the third command has an offset of E4 00 (00 E4 hex = 228 decimal).
TOTAL TRANS (total transaction) (2 bytes)	56 01	Indicates the total amount of PLC-3 data table words (low byte first) that are transferred for the entire transaction. In this example, there are three commands to complete the single transaction. The TOTAL TRANS equals 56 01 (01 56 hex = 342 words decimal or 684 bytes). If a file does not contain as many bytes as the TOTAL TRANS field, the transaction is rejected and you receive an error code in the status and extended status fields.
ADDRESS (variable number of bytes)	2C 08 0A 00	Specifies the PLC-3 data table address where the <i>word range read</i> will start. The combination of these bytes specifies the address flag, data table area, context, section, file, structure, and word location where the command will be executed. Not all commands need to specify all six levels. (For information on converting a PLC-3 address, see page 13-4.) In our example, we read PLC-3 binary file 10, word 0 which converts to 2C 08, 0A 00.
SIZE	E4	Specifies how many bytes of PLC-3 data table information you read in this transaction. The <i>word range read</i> command reads a maximum of 244 bytes per message packet. In this example, each of the three commands reads 228 bytes (E4 hex).
DLE ETX (2 bytes)	10 03	Indicates the termination of the message.
BCC (block check character)	6C	Used to check the accuracy of the message transmission. You can optionally use CRC bytes here. The BCC value must equal the 2's complement of the 8-bit sum of all data bytes between DLE STX and DLE ETX. (For more information on BCC and CRC error checking, see page 5-4.)
DLE ACK	10 06	Sent from the module (1770-KF2) back to the computer to indicate that the module successfully received the message. If the BCC value calculated by the module does not match the BCC value in the message packet, the module sends a DLE NAK (10 15 hex) instead of the DLE ACK (hex).

Reply		
Field	Value	Function
DLE STX (2 bytes)	10 02	Indicates the start of the reply message
DST (destination)	0A	Indicates the node address that the reply is being sent back to. In our example command message, the 1770-KF2 put its address in the source (SRC) byte before sending the command message to the 1775-KA. The 1775-KA takes the source byte from the command message and makes it the destination byte of the reply message. In our example, the reply message is sent back to the 1770-KF2, node address 012 octal (0A hex).
SRC (source)	09 p	Indicates the Data Highway node address that is the source of the message. In this example, the reply is being sent from the 1775-KA at node address 011 octal (09 hex).
CMD (command)	4F	Indicates the type of command. In a reply packet, 40 hex is added to the CMD byte to indicate that the packet is a reply. In this example, the CMD byte in the command message was 0F hex (<i>unprotected read</i>), so the CMD byte in the reply message is 4F hex.
STS (status)	00	Indicates the status of the message. If there is a problem with the message or the network, a status code appears in this byte. If the STS byte equals F0 or E0 hex, the exact error is contained in an EXT STS (extended status) byte. (For more information on STS codes, see page 8-2.) In our example, the message is successful (status code 00 hex).
TNS (transaction) (2 bytes)	02 00	Indicates a specific transaction value for each message. The TNS value for the reply message is the same as the TNS value for the command message. This allows the computer to keep track of commands and their associated replies. Since our example has three commands, each command must have a different TNS field.
DATA	228 bytes	In our example, the computer reads 228 bytes (114 words) of actual data from the PLC-3 data table starting at B10:0. Each word of data is presented low byte first. The second read command starts at B10:114 and the third at B10:228 based on the packet offset field.
DLE ETX (2 bytes)	10 03	Indicates the termination of the reply message.
BCC (block check character)		Used to check the accuracy of the message transmission. You can optionally use CRC bytes here. The BCC value must equal the 2's compliment of the 8-bit sum of all data bytes between DLE STX and DLE ETX.
DLE ACK	10 06	Sent from the computer back to the module (1770-KF2) to indicate that the computer successfully received the message. If the BCC value calculated by the module does not match the BCC value in the message packet, the module sends a DLE NAK (10 15 hex) instead of the DLE ACK (hex). If the module does not receive a DLE ACK or DLE NAK from the computer within approximately three seconds, it sends a DLE ENQ to see if re-transmission is necessary.

ASCII Codes

ASCII	Hex	Binary	Decimal
NUL	00	00000000	0
SOH	01	00000001	1
STX	02	00000010	2
ETX	03	00000011	3
EOT	04	00000100	4
ENQ	05	00000101	5
ACK	06	00000110	6
BEL	07	00000111	7
BS	08	00001000	8
HT	09	00001001	9
LF	0A	00001010	10
VT	0B	00001011	11
FF	0C	00001000	12
CR	0D	00001101	13
SO	0E	00001110	14
SI	0F	00001111	15
DLE	10	00010000	16
DC1	11	00010001	17
DC2	12	00010010	18
DC3	13	00010011	19
DC4	14	00010100	20
NAK	15	00010101	21
SYN	16	00010110	22
ETB	17	00010111	23
CAN	18	00011000	24
EM	19	00011001	25
SUB	1A	00011010	26
ESC	1B	00011011	27
FS	1C	00011100	28
GS	1D	00011101	29
RS	1E	00011110	30
US	1F	00011111	31
SP	20	00100000	32
!	21	00100001	33
"	22	00100010	34
#	23	00100011	35
\$	24	00100100	36
%	25	00100101	37
&	26	00100110	38
'	27	00100111	39
(28	00101000	40

ASCII	Hex	Binary	Decimal
)	29	00101001	41
*	2A	00101010	42
+	2B	00101011	43
,	2C	00101100	44
-	2D	00101101	45
.	2E	00101110	46
/	2F	00101111	47
0	30	00110000	48
1	31	00110001	49
2	32	00110010	50
3	33	00110011	51
4	34	00110100	52
5	35	00110101	53
6	36	00110110	54
7	37	00110111	55
8	38	00111000	56
9	39	00111001	57
:	3A	00111010	58
;	3B	00111011	59
<	3C	00111100	60
=	3D	00111101	61
>	3E	00111110	62
?	3F	00111111	63
@	40	01000000	64
A	41	01000001	65
B	42	01000010	66
C	43	01000011	67
D	44	01000100	68
E	45	01000101	69
F	46	01000110	70
G	47	01000111	71
H	48	01001000	72
I	49	01001001	73
J	4A	01001010	74
K	4B	01001011	75
L	4C	01001101	76
M	4D	01001101	77
N	4E	01001110	78
O	4F	01001111	79
P	50	01010000	80
Q	51	01010001	81

ASCII	Hex	Binary	Decimal
R	52	01010010	82
S	53	01010011	83
T	54	01010100	84
U	55	01010101	85
V	56	01010110	86
W	57	01010111	87
X	58	01011000	88
Y	59	01011001	89
Z	5A	01011010	90
[5B	01011011	91
\	5C	01011100	92
]	5D	01011101	93
^	5E	01011110	94
_	5F	01011111	95
`	60	01100000	96
a	61	01100001	97
b	62	01100010	98
c	63	01100011	99
d	64	01100100	100
e	65	01100101	101
f	66	01100110	102
g	67	01100111	103
h	68	01101000	104
i	69	01101001	105
j	6A	01101010	106
k	6B	01101011	107
l	6C	01101100	108
m	6D	01101101	109
n	6E	01101110	110
o	6F	01101111	111
p	70	01110000	112
q	71	01110001	113
r	72	01110010	114
s	73	01110011	115
t	74	01110100	116
u	75	01110101	117
v	76	01110110	118
w	77	01110111	119
x	78	01111000	120
y	79	01111001	121
z	7A	01111010	122
{	7B	01111011	123
	7C	01111100	124
}	7D	01111101	125

ASCII	Hex	Binary	Decimal
~	7E	01111110	126
DEL	7F	01111111	127
	80	10000000	128
	81	10000001	129
	82	10000010	130
	83	10000011	131
	84	10000100	132
	85	10000101	133
	86	10000110	134
	87	10000111	135
	88	10001000	136
	89	10001001	137
	8A	10001010	138
	8B	10001011	139
	8C	10001100	140
	8D	10001101	141
	8E	10001110	142
	8F	10001111	143
	90	10010000	145
	91	10010001	146
	92	10010010	147
	93	10010011	148
	94	10010100	149
	95	10010101	150
	96	10010110	151
	97	10010111	152
	98	10011000	153
	99	10011001	154
	9A	10011010	155
	9B	10011011	156
	9C	10011100	157
	9D	10011101	158
	9E	10011110	159
	9F	10011111	160
	A1	10100001	161
	A2	10100010	162
	A3	10100011	163
	A4	10100100	164
	A5	10100101	165
	A6	10100110	166
	A7	10100111	167
	A8	10101000	168
	A9	10101001	169
	AA	10101010	170
	AB	10101011	171

ASCII	Hex	Binary	Decimal
AC		10101100	172
AD		10101101	173
AE		10101110	174
AF		10101111	175
B0		10110000	176
B1		10110001	177
B2		10110010	178
B3		10110011	179
B4		10110100	180
B5		10110101	181
B6		10110110	182
B7		10110111	183
B8		10111000	184
B9		10111001	185
BA		10111010	186
BB		10111011	187
BC		10111100	188
BD		10111101	189
BE		10111110	190
BF		10111111	191
C0		11000000	192
C1		11000001	193
C2		11000010	194
C3		11000011	195
C4		11000100	196
C5		11000101	197
C6		11000110	198
C7		11000111	199
C8		11001000	200
C9		11001001	201
CA		11001010	202
CB		11001011	203
CC		11001100	204
CD		11001101	205
CE		11001110	206
CF		11001111	207
D0		11010000	208
D1		11010001	209
D2		11010010	210
D3		11010011	211
D4		11010100	212
D5		11010101	213
D6		11010110	214
D7		11010111	215
D8		11011000	216

ASCII	Hex	Binary	Decimal
D9		11011001	217
DA		11011010	218
DB		11011011	219
DC		11011100	220
DD		11011101	221
DE		11011110	222
DF		11011111	223
E0		11100000	224
E1		11100001	225
E2		11100010	226
E3		11100011	227
E4		11100100	228
E5		11100101	229
E6		11100110	230
E7		11100111	231
E8		11101000	232
E9		11101001	233
EA		11101010	234
EB		11101011	235
EC		11101100	236
ED		11101101	237
EE		11101110	238
EF		11101111	238
F0		11110000	240
F1		11110001	241
F2		11110010	242
F3		11110011	243
F4		11110100	244
F5		11110101	245
F6		11110110	246
F7		11110111	247
F8		11111000	248
F9		11111001	249
FA		11111010	250
FB		11111011	251
FC		11111100	252
FD		11111101	253
FE		11111110	254
FF		11111111	255

Symbols

Empty, [P-1](#), [P-2](#), [P-4](#), [P-5](#), [2-2](#),
[2-3](#), [6-1](#), [6-2](#), [6-3](#), [7-1](#)

Numbers

16-bit computer word, [11-7](#)
16-bit PLC word, [11-7](#)
1747, [9-3](#)
1747-KE, [9-3](#)
1747-L20, [9-3](#)
1747-L30, [9-3](#)
1747-L40, [9-3](#)
1747-L511, [9-3](#)
1747-L514, [9-3](#)
1747-L524, [9-3](#)
1747-L532, [9-3](#)
1747-L542, [9-4](#), [9-5](#), [9-6](#)
1747-PA2x, [9-3](#)
1761, [9-7](#)
1761-L16AWA, [9-7](#)
1761-L16BBB, [9-7](#)
1761-L16BWB, [9-7](#)
1761-L32AWA, [9-7](#)
1761-L32BWA, [9-7](#)
1761-L32BWB, [9-7](#)
1770, [9-8](#)
1770-KF2, [9-11](#)
1770-KF3, [9-3](#)
1770-KF3, connection to DH-485, [1-6](#)
1771, [9-14](#)
1771-KA, [9-14](#)
1771-KA2, [9-14](#)
1771-KC, [9-16](#)
1771-KG, [9-19](#)
1771-KGM, [9-19](#)
1774-KA, [9-14](#)
1774-PLC commands
 disable outputs, [7-6](#)
 enable program, [7-9](#)
 enable scan, [7-9](#)
1775, [9-21](#)

1775-KA, [9-21](#)
1775-S5, [9-21](#), [9-23](#)
1775-SR5, [9-21](#), [9-23](#)
1779, [9-24](#)
1779-KP5, [9-24](#)
1784, [9-25](#)
1784-KR, [9-3](#)
1784-KT, [9-25](#)
1784-KT2, [9-25](#)
1784-KT, Connection to Data Highway Plus,
 [2-1](#)
1784-KT2, Connection to Data Highway
 Plus, [2-1](#)
1785, [9-26](#), [9-33](#)
1785-KA, [9-26](#), [9-27](#)
1785-KA3, [9-28](#)
1785-KA5, [9-29](#), [9-30](#)
1785-KE, [9-11](#)
1785-KR, connection to DH-485, [1-6](#)
1785-KR5, connection to DH-485, [2-1](#)
6001-NET, description of, [P-5](#)

A

ADDR, [6-8](#)
 definition, [6-3](#)
Addressing, [13-1](#)
 1774-PLC, physical, [13-3](#)
 logical, [13-1](#)
 physical, [13-1](#)
 PLC-2, [13-3](#)
 conversion, [13-3](#)
 PLC-2/1774-PLC, logical, [13-2](#)
 PLC-3, [13-4](#)
 extended address, [13-5](#)
 PLC-3, logical, [13-5](#)
 PLC-3, physical, [13-7](#)
 PLC-3, symbolic, [13-8](#)
 PLC-5, [13-9](#)
 PLC-5, logical, [13-9](#), [13-10](#)
 PLC-5, logical binary, [13-10](#)
 PLC-5/250, logical binary, [13-13](#)
 symbolic, [13-1](#)
 types, [13-1](#)
APP DATA, definition, [2-8](#)

Application layer, [1-7](#)
 description of, [1-8](#)

Application layer protocol, [6-1](#)

Application program, how it sends and receives messages, [6-2](#)

Apply port configuration, [7-4](#)

ASCII codes, [15-1](#)
 numerical values, [15-1](#)

Asynchronous link, description of, [1-2](#)

asynchronous link, definition, [1-2](#)

Asynchronous link status code, STS byte, [8-2](#)

Asynchronous link status codes, [8-1](#)

B

Basic command set
 diagnostic counters reset, [7-22](#)
 Diagnostic loop, [7-8](#)
 Diagnostic read, [7-12](#), [7-19](#)
 diagnostic status, [7-6](#)
 protected bit write, [7-15](#)
 protected write, [7-16](#), [7-19](#)
 Set ENQs, [7-25](#)
 set NAKs, [7-25](#)
 set timeout, [7-27](#)
 set variables, [7-27](#)
 unprotected bit write, [7-30](#)
 unprotected read, [7-31](#)

Basice command set, unprotected write, [7-32](#)

Binary, [11-3](#)

Binary coded decimal, [11-3](#)

Block check character, determining the value of, [5-5](#)

C

Character transmission, [2-5](#)

CMD, [6-5](#)
 byte format, [6-5](#), [6-6](#), [6-7](#)
 definition, [6-3](#)

Command and reply, [1-9](#)

Command executers, [6-2](#)

Command initiators, [6-2](#)

Commands
 delivery order, [1-10](#)
 types, [1-11](#)

Comparable memory segments, [7-33](#)

counters, [9-1](#)

Cyclic redundancy check (CRC), [5-6](#)

D

Dat Highway Plus diagnostic counters, PLC-5, [9-32](#)

DATA, definition, [6-3](#)

Data bytes, description of, [1-9](#)

Data encoding, [11-1](#)

Data Highway
 baud rate, [1-3](#)
 description, [1-3](#)
 floating master, [1-3](#)
 node limit, [1-3](#)
 trunkline limit, [1-3](#)

Data Highway diagnostic counters
 1770-KF2, [9-8](#)
 1771-KA, [9-14](#)
 1771-KA2, [9-14](#)
 1771-KC, [9-16](#)
 1771-KE/KF, [9-8](#)
 1771-KG, [9-19](#)
 1771-KGM, [9-19](#)
 1774-KA, [9-14](#)
 1775-S5, [9-21](#)
 1775-SR5, [9-21](#)
 1775-KA, [9-21](#)
 1785-KA, [9-26](#), [9-27](#)

Data Highway Plus
 baud rate, [1-5](#)
 description, [1-5](#)
 example network, [1-5](#)
 formerly known as, [P-3](#)
 node limit, [1-5](#)
 PLC connections, [1-3](#), [1-5](#)

Data Highway Plus diagnostic counters
 1770-KF2, [9-11](#)
 1775-S5, [9-23](#)
 1775-SR5, [9-23](#)
 1779-KP5, [9-24](#)
 1784-KT, [9-25](#)
 1784-KT2, [9-25](#)
 1785-KA3, [9-28](#)
 1785-KA5, [9-29](#), [9-30](#)
 1785-KE, [9-11](#)
 PLC-5/250, [9-33](#)
 PLC-5/40,-5/60, [9-30](#)

Data Hoghway Plus, connection to DH-485, [1-6](#)

Data link layer, [1-7](#)
 definition, [1-7](#)

Data link layer protocol, description, [2-1](#)

Data link layer protocols, [2-4](#)

Data type ID, [7-29](#)

Data type size, [7-29](#)

Decimal, [11-2](#)

DH+ diagnostic counters, 1747-L542, [9-4](#),
[9-5](#), [9-6](#)

DH-485
 connection to Data Highway Plus, [1-6](#)
 description, [1-6](#)
 example network, [1-6](#)

DH485 diagnostic counters
 1747-KE, [9-3](#)
 1747-L20, [9-3](#)
 1747-L30, [9-3](#)
 1747-L40, [9-3](#)
 1747-L511, [9-3](#)
 1747-L514, [9-3](#)
 1747-L524, [9-3](#)
 1747-L532, [9-3](#)
 1747-PA2x, [9-3](#)
 1761-L16AWA, [9-7](#)
 1761-L16BBB, [9-7](#)
 1761-L16BWB, [9-7](#)
 1761-L32AWA, [9-7](#)
 1761-L32BWA, [9-7](#)
 1770-KF3, [9-3](#)
 1784-KR, [9-3](#)
 1761-L32BWB, [9-7](#)

Diagnostic counters, [9-1](#)
 how to read, [9-2](#)

Diagnostic status information, [10-2](#),
[10-5](#), [10-11](#), [10-15](#), [10-16](#),
[10-23](#)

DLE ACK, definition, [2-8](#)

DLE ENQ, definition, [2-8](#)

DLE ETX BCC/CRC, definition, [2-8](#)

DLE EXT BCC, [5-3](#)

DLE NAK, definition, [2-8](#)

DLE STX, [5-3](#)
 definition, [2-8](#)

Download, PLC, [12-6](#)

Download, [12-1](#)
 PLC-2, [12-7](#)
 PLC-3, [12-6](#), [12-8](#)
 PLC-5, [12-6](#), [12-8](#)
 PLC-5/15 series B rev F and later and
 other PLC-5, [12-10](#)
 Series B rev E and earlier, [12-9](#)

Driver, before you begin writing, [P-1](#)

DST, [6-4](#)
 definition, [6-3](#)

Duplicate message detection, [6-3](#)

E

Error codes, [1-11](#)
 returned by local node, [1-11](#)

EXT STS, [6-6](#)

EXT STS byte, EXT STS byte, [8-3](#)

EXT STS codes for command code 0F,
[8-4](#)

Extended addressing, [13-5](#)

F

Flag byte, [7-28](#)

floating master, description, [1-3](#)

FNC, [6-5](#)
 definition, [6-3](#)

Full-duplex
 description, [2-4](#)
 transmission symbols, [2-6](#)
 two-way simultaneous operation, [4-2](#)

Full-duplex line monitor examples
 PLC-2, [14-3](#)
 PLC-3, [14-6](#)

Full-duplex protocol
 diagrams, [4-10](#)
 packet format, [5-3](#)

H

Half-duplex
 line monitoring, [14-1](#)
 master polling responsibilities, [3-7](#)
 master transceiver, [3-6](#)
 Master/slave, [3-3](#)
 message characteristics, [3-7](#)
 message packet formats, [5-2](#)
 protocol diagrams, [3-11](#)
 slave transceiver actions, [3-9](#)

Half-duplex protocol
 communication characteristics, [2-2](#)
 description, [2-2](#)

Hexadecimal, [11-4](#)

L

Link layer packets, [5-2](#)

link protocol, definition, [2-2](#)

Local error, [8-2](#)

local node, definition of, [P-3](#)

local STS error codes, [8-2](#)

M

Manual
 purpose, [P-1](#)
 who should read, [P-1](#)

Master, [2-3](#)

Master packet, [5-2](#)

Message
 priority, [1-10](#)
 reply, [1-9](#)

Message bytes, data bytes, [1-9](#)
 message bytes, protocol bytes, [1-9](#)

Message packet format, command and reply, [6-3](#)

Message packet formats, [7-1](#)

Message packets, how they are sent, [1-9](#)

Message priority
 high, [1-10](#)
 how to specify, [1-10](#)
 normal, [1-10](#)

Message sink, [3-3](#)

Message source, [3-3](#)

Message transfer, poll with no message available, [3-11](#), [3-13](#)

Message transfer
 duplicate message, [3-11](#), [3-15](#)
 message sink full, [3-11](#), [3-16](#), [3-17](#)
 normal, [3-12](#), [4-10](#)
 poll with message returned, [3-11](#), [3-14](#)
 with ACK Destroyed, [3-11](#), [3-13](#)
 with invalid BCC, [3-11](#), [3-12](#)
 with message sink full, [4-14](#)
 with message sink full on the reply, [4-17](#)
 with NAK, [4-11](#)
 with NAK on reply, [4-15](#)
 with re-transmission, [4-13](#)
 with Timeout and ENQ, [4-12](#)
 with timeout and ENQ for the reply, [4-16](#)

Messages, command, [1-9](#)

Multidrop topology, [2-3](#)

N

network link, definition, [1-2](#)
 network's physical link, [1-1](#)
 node, definition of, [P-3](#)

Number systems, [11-2](#)

Numbering systems
 Binary, [11-3](#)

binary coded decimal, [11-3](#)
 decimal, [11-2](#)
 hexadecimal, [11-4](#)
 octal, [11-5](#)

O

Octal, [11-5](#)

Order of transmission, [11-6](#)

P

PCCCs
 apply port configuration, [7-4](#)
 return edit resource, [7-24](#)

physical communication link, [1-2](#)

PLC, definition of, [P-3](#)

PLC-2 commands
 enter download mode, [7-9](#)
 enter upload mode, [7-10](#)
 exit download/upload mode, [7-10](#)
 physical read, [7-13](#)
 physical write, [7-14](#)
 set data table size, [7-24](#)

PLC-3 commands
 bit write (write bit), [7-4](#)
 download request (download privilege), [7-8](#)
 file read (read file), [7-5](#), [7-10](#), [7-13](#)
 file write (write file), [7-11](#)
 restart request (restart), [7-23](#)
 shutdown request (shutdown), [7-28](#)
 upload request (upload privilege), [7-34](#)

PLC-5 commands, typed write (write block), [7-30](#)

PLC-5 family commands
 download all request (download), [7-7](#)
 download completed, [7-7](#)
 modify PLC-2 compatibility file, [7-12](#)
 read bytes physical (physical read), [7-19](#)
 read-modify-write (write bit), [7-20](#)
 read-modify-write n, [7-21](#)
 set processor mode, [7-26](#)
 typed read (read block), [7-28](#)
 upload all request (upload), [7-33](#)
 upload completed, [7-34](#)
 word range read (read block), [7-34](#)
 word range write (write block), [7-35](#)
 write bytes physical (physical write), [7-35](#)

Polling packet, [5-2](#)

Protocol, full-duplex, [2-4](#)

Protocol bytes, description of, [1-9](#)

Protocol environment
 definition, [4-3](#)
 message characteristics, [4-4](#)
 message sink, [4-3](#)
 message source, [4-3](#)
 transmitter operation, [4-5](#)

R

Receiver operation, [4-7](#)
 ACK, [4-8](#)
 DLE ENQ, [4-8](#)
 NAK, [4-8](#)
 Related Products, [P-4](#)
 Remote error, [8-2](#)
 remote node, definition of, [P-3](#)
 Remote STS and EXT STS codes,
 meaning, from a PLC-3, [8-6](#)
 Remote STS Codes, meaning, sent from a
 PLC-2 or 1774-PLC, [8-5](#)
 remote STS error codes, [8-3](#)
 responder, definition, [1-8](#)
 Return edit resource, [7-24](#)

S

Sender, definition, [1-8](#)
 SIZE, [6-8](#)
 definition, [6-3](#)
 Slave packet, [5-2](#)
 Slaves, [2-3](#)
 SLC-500 family commands, reading and
 writing, using PLC-2 terminology,
[7-38](#)
 SLC-500 family commands
 protected typed logical read, three
 address fields, [7-17](#)
 protected typed logical write, three
 address fields, [7-18](#)
 read link parameters, [7-20](#)
 reading and writing, using SLC
 terminology, [7-38](#)
 set link parameters, [7-25](#)
 Software layers, [1-7](#)
 SRC, [6-4](#)
 status bytes
 1771-KA2, 1771-KA, 1771-KG,
 1771-KCKD, [10-7](#)
 1771-KE/KF, 1771-KGM, 1770-KF2,
[10-7](#)

Status codes, asynchronous link, [8-1](#)
 Status DATA
 1770-KF3, [10-7](#)
 1773-KA, [10-11](#)
 1779-KP5, [10-14](#)
 1784-KR, [10-15](#)
 1784-KT, -KT2, [10-15](#)
 1785-KA, [10-16](#), [10-17](#)
 1785-KA3, [10-17](#)
 1785-KE, [10-19](#)
 1785-LT (PLC-5/15), [10-20](#)
 1785-LT3 (PLC-5/12), [10-21](#), [10-22](#)
 5130-RM1, -RM2 (PLC-5/250), [10-23](#)
 6008-LTV (PLC-5 VME), [10-20](#)
 SLC APS, [10-2](#)
 SLC-5/01, [10-3](#), [10-4](#), [10-6](#)
 STS, [6-6](#)
 definition, [6-3](#)
 STS byte, description, [8-2](#)
 Symbol, definition, [2-6](#)
 Symbols
 for full-duplex, [2-8](#)
 for half-duplex, [2-7](#)

T

TNS, [6-7](#)
 definition, [6-3](#)
 Transmitter operation
 DLE ACK, [4-5](#), [4-8](#)
 DLE ENQ, [4-5](#)
 DLE NAK, [4-5](#)
 software logic, [4-6](#)
 Type/Data parameter
 data type ID, [7-29](#)
 date type size, [7-29](#)
 flag byte, [7-28](#)

U

Upload, [12-1](#)
 from a PLC, [12-2](#)
 PLC-2, [12-2](#)
 PLC-3, [12-2](#)
 PLC-5, [12-3](#)
 PLC-5/15 Series B rev E and earlier,
[12-4](#)
 PLC-5/15 Series B rev F and later and
 other PLC-5, [12-5](#)
 Upload and download, [12-1](#)
 constraints, [12-1](#), [12-4](#)
 Uploadable memory segments, [7-33](#)



Allen-Bradley Publication Problem Report

If you find a problem with our documentation, please complete and return this form.

Pub. Name DF1 Protocol and Command Set Reference Manual

Cat. No. various Pub. No. 1770-6.5.16 Pub. Date October 1996 Part No. 4046109-05

Check Problem(s) Type:	Describe Problem(s):	Internal Use Only
<input type="checkbox"/> Technical Accuracy 	<input type="checkbox"/> text <input type="checkbox"/> illustration	
<input type="checkbox"/> Completeness What information is missing?	<input type="checkbox"/> procedure/step <input type="checkbox"/> illustration <input type="checkbox"/> definition	<input type="checkbox"/> info in manual (accessibility)
	<input type="checkbox"/> example <input type="checkbox"/> guideline <input type="checkbox"/> feature	<input type="checkbox"/> info not in manual
	<input type="checkbox"/> explanation <input type="checkbox"/> other	
<input type="checkbox"/> Clarity What is unclear?		
<input type="checkbox"/> Sequence What is not in the right order?		
<input type="checkbox"/> Other Comments Use back for more comments.		

Your Name _____ Location/Phone _____

Return to: Marketing Communications, Allen-Bradley Co., 1 Allen-Bradley Drive, Mayfield Hts., OH 44124-6118 Phone: (216)646-3176
 FAX: (216)646-4320

PLEASE FASTEN HERE (DO NOT STAPLE)

Other Comments

PLEASE FOLD HERE

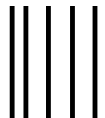

NO POSTAGE
NECESSARY
IF MAILED
IN THE
UNITED STATES

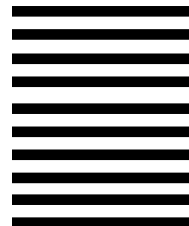

PLEASE REMOVE

BUSINESS REPLY MAIL
FIRST-CLASS MAIL PERMIT NO. 18235 CLEVELAND OH

POSTAGE WILL BE PAID BY THE ADDRESSEE



Allen-Bradley

1 ALLEN BRADLEY DR
MAYFIELD HEIGHTS OH 44124-9705





Allen-Bradley, a Rockwell Automation Business, has been helping its customers improve productivity and quality for more than 90 years. We design, manufacture and support a broad range of automation products worldwide. They include logic processors, power and motion control devices, operator interfaces, sensors and a variety of software. Rockwell is one of the world's leading technology companies.

Worldwide representation.



Argentina • Australia • Austria • Bahrain • Belgium • Brazil • Bulgaria • Canada • Chile • China, PRC • Colombia • Costa Rica • Croatia • Cyprus • Czech Republic • Denmark • Ecuador • Egypt • El Salvador • Finland • France • Germany • Greece • Guatemala • Honduras • Hong Kong • Hungary • Iceland • India • Indonesia • Ireland • Israel • Italy • Jamaica • Japan • Jordan • Korea • Kuwait • Lebanon • Malaysia • Mexico • Netherlands • New Zealand • Norway • Pakistan • Peru • Philippines • Poland • Portugal • Puerto Rico • Qatar • Romania • Russia-CIS • Saudi Arabia • Singapore • Slovakia • Slovenia • South Africa, Republic • Spain • Sweden • Switzerland • Taiwan • Thailand • Turkey • United Arab Emirates • United Kingdom • United States • Uruguay • Venezuela • Yugoslavia

Allen-Bradley Headquarters, 1201 South Second Street, Milwaukee, WI 53204 USA, Tel: (1) 414 382-2000 Fax: (1) 414 382-4444